



Pneumatic: Push-to-Connect

Prestolok PLP

Prestolok Composite

Prestolok PLM

Prestolok PLS

Oscillating Elbows







Prestolok PLP Push-to-Connect Fittings

Prestolok PLP push-to-connect metal fittings with its wide variety configurations allows you to find the perfect product to meet your needs, optimizing the use of your equipment.

Product Features:

- Stainless steel grab ring
- Nickel-plated brass body
- Nitrile seal
- Polyacetal release button
- Corrosion resistance
- NPT, BSPT, BSPP, and metric threads

Markets:

- Industrial
- Automotive
- Climate Control
- Welding
- Packaging

Applications:

- Air
- Oil
- Inert Gases
- Vacuum

Specifications:

Pressure Range Up to 300 psi depending on tubing









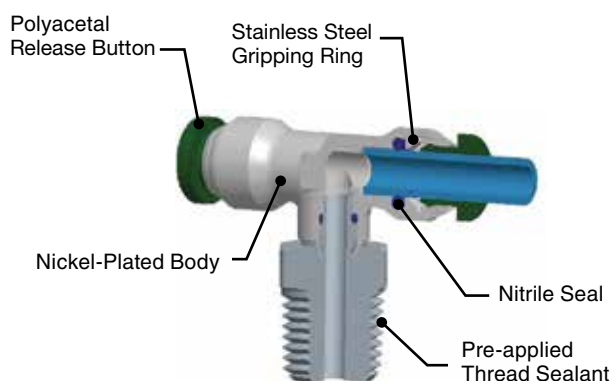



Temperature Range 0° to +200°F

Note: Vacuum applications are dependent upon temperature and type of tubing used

Compatible Tubing:

- Polyethylene
- Polypropylene
- Plasticized Nylon
- Unplasticized Nylon
- Polyurethane 90 Durometer Shore A
- Polyurethane 94 Duromete Shore A



Tube to Male NPTF	68PLPR Male Connector Round Body  p. A7	W169PLP Male Elbow Swivel  p. A8	W169PLPNS Male Elbow  p. A8	W171PLP Male Run Tee Swivel  p. A8	W172PLP Male Branch Tee Swivel  p. A9	W68PLP Male Connector  p. A6
	Tube to Tube	164PLP Union Tee  p. A7	165PLP Union Elbow  p. A8	62PLP Union  p. A6	Tube to Female NPTF	66PLP Female Connector  p. A6
Bulkhead Unions		62PLPBH Bulkhead Union  p. A6	66PLPBH Female Bulkhead Union  p. A6	Tube to Straight Thread		Tube to Male BSPP
			PLPHBF4-B Male Connector  p. A7			

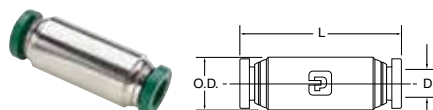

62PLP Union

PART NO.	TUBE SIZE	O.D.	L	FLOW DIA. D
62PLP-2	1/8	.375	1.40	.094
62PLP-3	3/16	.437	1.41	.156
62PLP-5/32	5/32	.375	1.41	.125
62PLP-4	1/4	.500	1.43	.188
62PLP-5	5/16	.562	1.65	.250
62PLP-6	3/8	.625	1.66	.312
62PLP-8	1/2	.750	1.82	.375

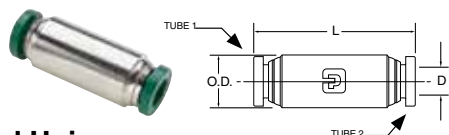

62PLP Unequal Union

PART NO.	TUBE 1 SIZE (IN)	TUBE 2 SIZE (IN)	O.D.	L	FLOW DIA. D
62PLP-5/32-2	5/32	1/8	.375	1.41	.094
62PLP-4-2	1/4	1/8	.500	1.43	.094
62PLP-4-5/32	1/4	5/32	.500	1.43	.125
62PLP-4-6	1/4	3/8	.625	1.66	.188
62PLP-6-8	3/8	1/2	.750	1.82	.312

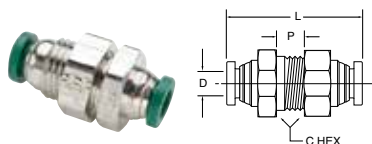

62PLPBH Bulkhead Union

PART NO.	TUBE SIZE (IN)	BULKHEAD HOLE DIA. B	C HEX	P MAX.	L	D
62PLPBH-2	1/8	7/16	9/16	.39	1.40	.094
62PLPBH-5/32	5/32	7/16	9/16	.39	1.41	.125
62PLPBH-4	1/4	9/16	11/16	.29	1.43	.188
62PLPBH-5	5/16	5/8	3/4	.60	1.65	.250
62PLPBH-6	3/8	3/4	7/8	.54	1.66	.312
62PLPBH-8	1/2	7/8	1	.66	2.04	.375

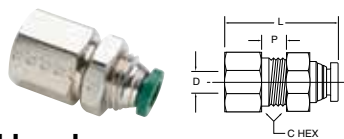

66PLPBH Female Bulkhead

PART NO.	TUBE SIZE (IN)	PIPE THD (NPTF)	C HEX	P MAX.	L	FLOW DIA. D	BKHD HOLE DIA.
66PLPBH-5/32-4	5/32	1/4	11/16	.19	1.39	.125	1/2
66PLPBH-4-4	1/4	1/4	11/16	.24	1.35	.188	9/16
66PLPBH-6-6	3/8	3/8	1	.22	1.47	.312	7/8
66PLPBH-8-6	1/2	3/8	1	.35	1.56	.344	7/8

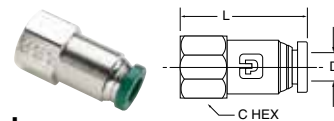

66PLP Female Connector

PART NO.	TUBE SIZE	PIPE THREAD (NPTF)	C HEX	L	FLOW DIA. D
66PLP-2-2	1/8	1/8	9/16	1.17	.094
66PLP-2-4	1/8	1/4	11/16	1.34	.094
66PLP-3-2	3/16	1/8	9/16	1.13	.156
66PLP-5/32-2	5/32	1/8	9/16	1.17	.125
66PLP-5/32-4	5/32	1/4	11/16	1.38	.125
66PLP-4-2	1/4	1/8	9/16	1.17	.188
66PLP-4-4	1/4	1/4	11/16	1.38	.188
66PLP-5-2	5/16	1/8	9/16	1.25	.250
66PLP-5-4	5/16	1/4	11/16	1.45	.250
66PLP-6-4	3/8	1/4	11/16	1.46	.312
66PLP-6-6	3/8	3/8	13/16	1.51	.312

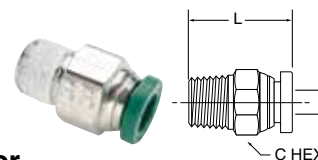

W68PLP Male Connector

PART NO.	TUBE SIZE (IN)	PIPE THD (NPTF)	C HEX	L	FLOW DIA. D
W68PLP-2-1	1/8	1/16	3/8	.79	.094
W68PLP-2-2	1/8	1/8	7/16	.79	.094
W68PLP-2-4	1/8	1/4	9/16	1.02	.094
W68PLP-3-2	3/16	1/8	7/16	.85	.156
W68PLP-3-4	3/16	1/4	9/16	1.01	.156
W68PLP-5/32-1	5/32	1/16		.88	.940
W68PLP-5/32-2	5/32	1/8	7/16	.80	.125
W68PLP-5/32-4	5/32	1/4	9/16	1.03	.125
W68PLP-4-1	1/4	1/16	1/2	1.07	.141
W68PLP-4-2	1/4	1/8	1/2	.89	.188
W68PLP-4-4	1/4	1/4	9/16	1.00	.188
W68PLP-4-6	1/4	3/8	3/4	1.04	.188
W68PLP-5-2	5/16	1/8	9/16	1.18	.250
W68PLP-5-4	5/16	1/4	9/16	1.04	.250
W68PLP-5-6	5/16	3/8	11/16	1.04	.250
W68PLP-6-2	3/8	1/8	5/8	1.21	.250
W68PLP-6-4	3/8	1/4	5/8	1.08	.312
W68PLP-6-6	3/8	3/8	11/16	1.02	.312
W68PLP-6-8	3/8	1/2	7/8	1.28	.312
W68PLP-8-4	1/2	1/4	13/16	1.44	.344
W68PLP-8-6	1/2	3/8	13/16	1.24	.344
W68PLP-8-8	1/2	1/2	7/8	1.35	.375
68PLP-5/32-4LT*	5/32	1/4-28	7/16	.88	.093

*SAE-LTThreads

68PLP-X-0 Male Connector

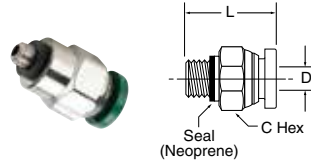

PART NO.	TUBE SIZE (IN)	PIPE THREAD (NPTF)	C HEX	L	FLOW DIA. D
68PLP-2-0	1/8	10X32	3/8	.92	.094
68PLP-5/32-0	5/32	10X32	3/8	.90	.090
68PLP-4-0	1/4	10X32	1/2	.96	.094

164PLP Union Tee

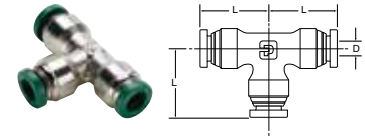

PART NO.	TUBE SIZE (IN)	L	FLOW DIA. D
164PLP-2	1/8	.74	.094
164PLP-3	3/16	.82	.156
164PLP-5/32	5/32	.77	.125
164PLP-4	1/4	.85	.188
164PLP-5	5/16	.97	.250
164PLP-6	3/8	1.01	.250
164PLP-8	1/2	1.15	.375

68PLPR Round Body Male Connector

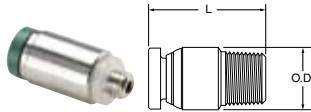

PART NO.	TUBE SIZE	THREAD SIZE NPTF	INTERNAL HEX BROACH	BODY DIA. O.D.	L	FLOW DIA.
68PLPR-2-0*	1/8	10-32	3/32	3/8"	.89	.094
68PLPR-5/32-0*	5/32	10-32	3/32	3/8"	.91	.094
68PLPR-4-0*	1/4	10-32	3/32	1/2"	.95	.094
W68PLPR-5/32-1	5/32	1/16	1/8	7/16"	.87	.125
W68PLPR-5/32-2	5/32	1/8	1/8	7/16"	.79	.125
W68PLPR-4-1	1/4	1/16	5/32	1/2"	1.06	.156
W68PLPR-4-2	1/4	1/8	3/16	1/2"	.88	.188
W68PLPR-4-4	1/4	1/4	3/16	5/8"	.99	.188

*10-32 seal is neoprene

PLPHBF4-B Male Connector BSPP

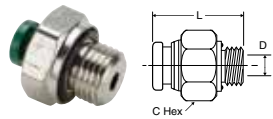

PART NO.	TUBE SIZE (IN)	PIPE THD BSPP	C HEX	L	FLOW DIA. D
3-1/8PLPHBF4-B	3/16	1/8-28	11/16	.96	.156
3-1/4PLPHBF4-B	3/16	1/4-19	3/4	.97	.156
4-1/8PLPHBF4-B	1/4	1/8-28	11/16	1.13	.188
4-1/4PLPHBF4-B	1/4	1/4-19	3/4	1.13	.188
4-3/8PLPHBF4-B	1/4	3/8-19	7/8	1.13	.188
6-1/4PLPHBF4-B	3/8	1/4-19	3/4	1.26	.256
6-3/8PLPHBF4-B	3/8	3/8-19	7/8	1.26	.312
6-1/2PLPHBF4-B	3/8	1/2-14	1-1/16	1.26	.312
8-3/8PLPHBF4-B	1/2	3/8-19	7/8	1.41	.452
8-1/2PLPHBF4-B	1/2	1/2-14	1-1/16	1.37	.452

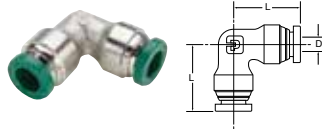

165PLP Union Elbow

PART NO.	TUBE SIZE (IN)	L	FLOW DIA. D
165PLP-2	1/8	.74	.094
165PLP-5/32	5/32	.77	.125
165PLP-4	1/4	.85	.188
165PLP-5	5/16	.97	.250
165PLP-6	3/8	1.01	.312
165PLP-8	1/2	1.15	.375

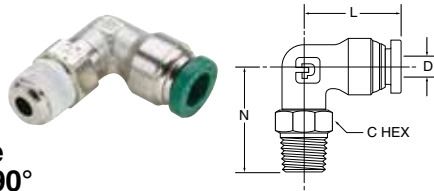

W169PLP Male Elbow Swivel 90°

PART NO.	TUBE SIZE (IN)	PIPE THREAD (NPTF)	C HEX	L	N	FLOW DIA. D
W169PLP-2-1	1/8	1/16	3/8	.74	.93	.160
W169PLP-2-2	1/8	1/8	7/16	.74	.92	.094
169PLP-2-0*	1/8	10-32	3/8	.74	.74	.080
W169PLP-2-4	1/8	1/4	9/16	.74	1.10	.094
W169PLP-3-2	3/16	1/8	7/16	.82	.92	.156
W169PLP-5/32-1	5/32	1/16	3/8	.84	.93	.160
W169PLP-5/32-2	5/32	1/8	7/16	.77	.92	.125
W169PLP-5/32-4	5/32	1/4	9/16	.77	1.10	.125
169PLP-5/32-0*	5/32	10-32	3/8	.85	.74	.080
W169PLP-4-1	1/4	1/16	3/8	.84	.93	.160
W169PLP-4-2	1/4	1/8	7/16	.85	.92	.156
W169PLP-4-4	1/4	1/4	9/16	.85	1.10	.156
W169PLP-4-6	1/4	3/8	11/16	.85	1.19	.156
169PLP-4-0*	1/4	10-32	3/8	.85	.74	.080
W169PLP-5-2	5/16	1/8	9/16	.97	1.02	.250
W169PLP-5-4	5/16	1/4	9/16	.97	1.24	.250
W169PLP-6-2	3/8	1/8	9/16	1.01	1.02	.250
W169PLP-6-4	3/8	1/4	9/16	1.01	1.24	.250
W169PLP-6-6	3/8	3/8	11/16	1.01	1.24	.250
W169PLP-6-8	3/8	1/2	7/8	1.01	1.48	.250
W169PLP-8-4	1/2	1/4	9/16	1.15	1.28	.312
W169PLP-8-6	1/2	3/8	11/16	1.15	1.31	.312
W169PLP-8-8	1/2	1/2	7/8	1.15	1.52	.312

*10-32 seal is neoprene

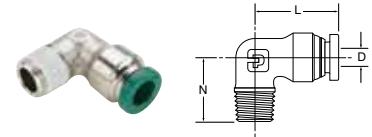

W169PLPNS Male Elbow 90°

PART NO.	TUBE (IN)	PIPE THD (NPTF)	L	N	FLOW DIA. D
W169PLPNS-2-2	1/8	1/8	.74	.67	.094
W169PLPNS5/32-2	5/32	1/8	.77	.67	.125
W169PLPNS5/32-4	5/32	1/4	.77	.87	.125
W169PLPNS-4-2	1/4	1/8	.85	.67	.188
W169PLPNS-4-4	1/4	1/4	.85	.87	.188
W169PLPNS-5-2	5/16	1/8	.97	.75	.234
W169PLPNS-5-4	5/16	1/4	.97	.94	.250
W169PLPNS-6-4	3/8	1/4	1.01	.94	.312
W169PLPNS-6-6	3/8	3/8	1.01	1.01	.312
W169PLPNS-6-8	3/8	1/2	1.01	1.27	.312
W169PLPNS-8-6	1/2	3/8	1.15	1.00	.375
W169PLPNS-8-8	1/2	1/2	1.15	1.27	.375
169PLPNS532-4LT*	5/32	1/4-28	.60	.48	.090

* SAE-LT Threads

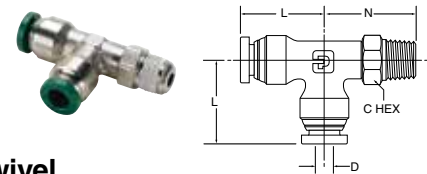

W171PLP Male Run Tee Swivel

PART NO.	TUBE SIZE (IN)	PIPE THREAD (NPTF)	C HEX	L	N	FLOW DIA. D
W171PLP-2-2	1/8	1/8	7/16	.74	.92	.094
W171PLP-5/32-2	5/32	1/8	7/16	.77	.92	.125
W171PLP-4-2	1/4	1/8	7/16	.85	.92	.156
W171PLP-4-4	1/4	1/4	9/16	.85	1.10	.156
W171PLP-4-6	1/4	3/8	11/16	.85	1.24	.156
W171PLP-5-2	5/16	1/8	9/16	.97	1.02	.250
W171PLP-5-4	5/16	1/4	9/16	.97	1.24	.250
W171PLP-6-4	3/8	1/4	9/16	1.01	1.24	.250
W171PLP-6-6	3/8	3/8	11/16	1.01	1.24	.250
W171PLP-8-6	1/2	3/8	11/16	1.15	1.31	.312
W171PLP-8-8	1/2	1/2	7/8	1.15	1.52	.312

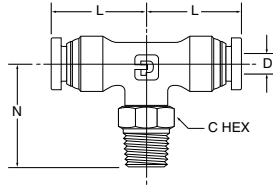

**W172PLP Male
Branch Tee Swivel**

PART NO.	TUBE SIZE (IN)	PIPE THREAD (NPTF)	C HEX	L	N	FLOW DIA. D
W172PLP-2-2	1/8	1/8	7/16	.74	.92	.094
W172PLP-3-2	3/16	1/8	7/16	.82	.92	.156
W172PLP-5/32-2	5/32	1/8	7/16	.77	.92	.125
W172PLP-4-2	1/4	1/8	7/16	.85	.92	.156
W172PLP-4-4	1/4	1/4	9/16	.85	1.10	.156
W172PLP-4-6	1/4	3/8	11/16	.85	1.10	.156
W172PLP-5-2	5/16	1/8	9/16	.97	1.02	.250
W172PLP-5-4	5/16	1/4	9/16	.97	1.24	.250
W172PLP-6-4	3/8	1/4	9/16	1.01	1.24	.250
W172PLP-6-6	3/8	3/8	11/16	1.01	1.24	.250
W172PLP-6-8	3/8	1/2	7/8	1.00	1.48	.250
W172PLP-8-4	1/2	1/4	9/16	1.15	1.30	.312
W172PLP-8-6	1/2	3/8	11/16	1.15	1.31	.312
W172PLP-8-8	1/2	1/2	7/8	1.15	1.52	.312



Prestolok PLP Composite Push-to-Connect Fittings

Prestolok push-to-connect composite fittings with its wide variety configurations allows you to find the perfect product to meet your needs, optimizing the use of your equipment.

Product Features:

- Stainless steel grab ring
- Glass-reinforced nylon 6.6 body
- Nitrile D-seal
- Nylon release button
- Corrosion and chemical resistance
- NPT, BSPT, BSPP, and metric threads

Markets:

- Pneumatic
- Industrial
- Robotic
- Automation
- Printing
- Packaging
- Textile

Applications:

- Air
- Cutting Fluids
- Inert Gases
- Vacuum

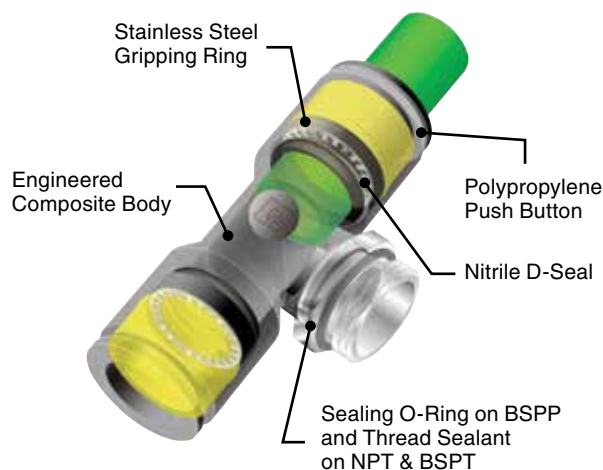

Specifications:

Pressure Range Up to 290 psi depending on tubing (3/16" size only) Up to 260 psi depending on tubing

Temperature Range -4° to +175°F (3/16" size only) 5° to +155°F

Vacuum Capability 28" Hg

Compatible Tubing:

- Semi-rigid nylon
- Polyurethane 95 Durometer Shore A
- Nylon
- Fluoropolymer

Tube to Male NPTF	W369PLP Male Elbow  p. A16	W369PLPX Extended Male Elbow  p. A18	W379PLP 45° Male Elbow  p. A18	W372PLP Male Branch Tee  p. A19	W371PLP Male Run Tee  p. A21	W368PLP Male Y Connector  p. A23
	W369PLPBJ Single Banjo  p. A24	W369PLPTJ Twin Banjo  p. A26	W68LF Male Connector  p. A14	Tube to Male BSPT	W369PLP Male Elbow  p. A16	W372PLP Male Branch Tee  p. A20
W68LF Male Connector  p. A15	Tube to Female NPTF	66LF Female Connector  p. A14	377PLP Female Branch Tee  p. A21		370PLP Female Elbow  p. A24	Tube to Straight Thread
Tube to Tube		32PLP Union  p. A27	365PLP Union Elbow  p. A27	364PLP Union Tee  p. A28	362PLP Union Y  p. A28	
	24PLPD Double Multiple Tee  p. A30	347PLP Cross  p. A30	32PLPRC Connector for 2 Tubes  p. A34	Tube to Metric Tube	32PLP Converter Union  p. A27	
Bulkhead Unions	32PLPBH Bulkhead Union  p. A29	365PLPBH Bulkhead Elbow  p. A29	32PLPBHP Plug-in Bulkhead Union  p. A35			
	Standpipes	W68PLPSP Male Standpipe NPTF  p. A22	W68PLPSP Male Standpipe BSPT  p. A22	W68PLPSP Male Standpipe BSPP  p. A23	Plug-ins	369PLPSP Plug-In Elbow  p. A30
379PLPSP Plug-In 45° Elbow  p. A31		372PLPSP Plug-In Branch Tee  p. A31	371PLPSP Plug-In Run Tee  p. A31	362PLPSP Plug-In Y  p. A32		67PLP Tube Reducer  p. A33

Auxiliary Component	63PLP Double Male Union  p. A32	639PLP Plug  p. A33	Clip  p. A34	3151 End Cap  p. A34	3110-3330 End Cap  p. A35	
	W68LF Male Connector  p. A15	W369PLP Male Elbow  p. A17	W369PLPX Extended Male Elbow  p. A18	W379PLP 45° Male Elbow  p. A19	W372PLP Male Branch Tee  p. A20	W371PLP Male Run Tee  p. A22
W368PLP Male Y Connector  p. A23	W368PLPD Double Y Male Connector  p. A24	W369PLPBJ Single Banjo  p. A24	Metric Tube to Male BSPP	68LF Male Connector  p. A16	369PLP Male Elbow  p. A17	369PLPX Extended Male Elbow  p. A18
379PLP 45° Male Elbow  p. A19	372PLP Male Branch Tee  p. A21	371PLP Male Run Tee  p. A22		368PLP Male Y Connector  p. A23	368PLPD Double Y Male Connector  p. A24	
Metric Tube to NPTF	W68LF Male Connector  p. A15	W369PLP Male Elbow  p. A17	W372PLP Male Branch Tee  p. A20	Metric Tube to Female BSPP	66LF Female Connector  p. A14	370PLP Female Elbow  p. A24
	68LFR Male Connector  p. A15	Metric Tube to Metric Tube	32PLP Union  p. A27		365PLP Union Elbow  p. A27	364PLP Union Tee  p. A28
362PLPD Double Union Y  p. A29	24PLP Multiple Tee  p. A29		24PLPD Double Multiple Tee  p. A30	347PLP Cross  p. A30	32PLPRC Connector for 2 Tubes  p. A34	32PLPDRC Connector for 3 Tubes  p. A34
Metric Bulkhead Unions	32PLPBH Bulkhead Union  p. A29		365PLPBH Bulkhead Elbow  p. A29			

Metric Plug-ins	369PLPSP Plug-In Elbow	369PLPSPX Extended Plug-In Elbow	379PLPSP Plug-In 45° Male Elbow	372PLPSP Plug-In Branch Tee	371PLPSP Plug-In Run Tee	362PLPSP Plug-In Y
	 p. A30	 p. A31	 p. A31	 p. A31	 p. A32	 p. A32
362PLPSPD Double Plug-In Y	67PLP Tube Reducer	32PLPSP Tube Expander	32PLPSP Tube Converter	322PLPSP Barbed Connector	Metric Banjo Fittings	369PLPBJ Single Banjo
 p. A32	 p. A33	 p. A33	 p. A33	 p. A33		 p. A25
369PLPBJB Single Banjo Body	32PLPDJB Double Banjo Body	369PLPTJB Twin Banjo Body	68BJB Single Banjo Bolt	68BJBD Double Banjo Bolt	68BJBT Triple Banjo Bolt	66BJB Female Banjo Bolt
 p. A25	 p. A25	 p. A25	 p. A25	 p. A26	 p. A26	 p. A26
376PLPBJ Banjo with Female Bolt	369PLPTJ Twin Banjo	32PLPDJ Double Banjo	Auxiliary Component	63PLP Double Male Union	639PLP Plug	Clip
 p. A26	 p. A26	 p. A26		 p. A32	 p. A33	 p. A34
3151 End Cap	3110-3330 End Cap					
 p. A34	 p. A35					

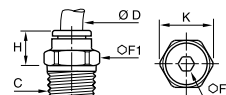

66LF Female Connector BSPP

PART NO.	TUBE SIZE	THREAD BSPP	E MM	F MM	H MM
66LF-4M-M5	4	M5X0.8	6.5	8	19.5
66LF-4M-2G	4	1/8	9.5	13	22.5
66LF-4M-4G	4	1/4	13.5	16	26.5
66LF-6M-2G	6	1/8	9.5	13	24.5
66LF-6M-4G	6	1/4	13.5	16	28.5
66LF-8M-2G	8	1/8	9.5	13	29.0
66LF-8M-4G	8	1/4	13.5	16	33.0
66LF-8M-6G	8	3/8	14.0	19	34.0
66LF-10M-4G	10	1/4	13.5	16	36.0
66LF-10M-6G	10	3/8	14.0	19	36.0
66LF-10M-8G	10	1/2	19.5	24	41.5
66LF-12M-4G	12	1/4	14.0	19	39.5
66LF-12M-6G	12	3/8	14.0	19	40.0
66LF-12M-8G	12	1/2	19.5	24	45.5
66LF-14M-6G	14	3/8	14.0	22	42.5
66LF-16M-8G	16	1/2	15.0	27	49.0

W68LF Male Connector NPT

PART NO.	TUBE SIZE	C NPT	F1 MM	F2 IN	H IN	K IN
W68LF-2-1	1/8	1/16	10	.07	.413	.433
W68LF-2-2	1/8	1/8	11	.07	.283	.472
W68LF-2-4	1/8	1/4	14	.07	.315	.591
W68LF-4M-2	5/32 (4M)	1/8	11	.11	.334	.472
W68LF-4M-4	5/32 (4M)	1/4	14	.11	.275	.590
W68LF-3-2	3/16	1/8	11	.12	.610	.510
W68LF-3-4	3/16	1/4	14	.16	.590	.650
W68LF-4-2	1/4	1/8	11	.16	.472	.472
W68LF-4-4	1/4	1/4	14	.16	.374	.590
W68LF-4-6	1/4	3/8	18	.19	.295	.767
W68LF-8M-2	5/16 (8M)	1/8	13	.19	.787	.551
W68LF-8M-4	5/16 (8M)	1/4	14	.25	.661	.590
W68LF-8M-6	5/16 (8M)	3/8	18	.25	.464	.767
W68LF-6-2	3/8	1/8	16	.16	.894	.689
W68LF-6-4	3/8	1/4	16	.28	.807	.689
W68LF-6-6	3/8	3/8	18	.28	.689	.767
W68LF-6-8	3/8	1/2	22	.28	.610	.945
W68LF-8-4	1/2	1/4	22	.25	1.100	.945
W68LF-8-6	1/2	3/8	22	.28	1.100	.945
W68LF-8-8	1/2	1/2	22	.28	1.100	.945



66LF Female Connector NPT

PART NO.	TUBE SIZE	THREAD NPT	F MM	G IN	H IN	E IN
66LF-2-2	1/8	1/8	13	.43	.87	.37
66LF-2-4	1/8	1/4	16	.43	1.05	.55
66LF-4M-2	5/32 (4M)	1/8	13	.33	.89	.37
66LF-4M-4	5/32 (4M)	1/4	16	.33	1.06	.55
66LF-3-2	3/16	1/8	14		1.06	
66LF-3-4	3/16	1/4	17		1.26	
66LF-4-2	1/4	1/8	13	.42	.98	.37
66LF-4-4	1/4	1/4	16	.42	1.16	.55
66LF-8M-2	5/16 (8M)	1/8	13	.53	1.14	.37
66LF-8M-4	5/16 (8M)	1/4	16	.53	1.32	.55
66LF-6-2	3/8	1/8	16	.61	1.22	.37
66LF-6-4	3/8	1/4	16	.61	1.40	.55
66LF-6-6	3/8	3/8	22	.61	1.52	.65
66LF-8-4	1/2	1/4	20	.84	1.73	.47
66LF-8-6	1/2	3/8	22	.85	1.81	.65
66LF-8-8	1/2	1/2	24	.85	1.93	.77

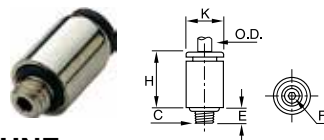

68LFR Male Connector UNF

PART NO.	TUBE SIZE	C UNF	E IN	F MM	H IN	K IN
68LFR-2-0	1/8	10-32	.13	2.0	.49	.32
68LFR-4M-0	5/32 (4M)	10-32	.13	2.0	.54	.34
68LFR-4-1	1/4	1/16	-	3.0	.63	.42
68LFR-4-0	1/4	10-32	.13	2.0	.64	.46
68LFR-4-M5	1/4	M5	.14	2.5	.65	.41
68LFR-4-M7	1/4	M7	.18	4.0	.65	.41

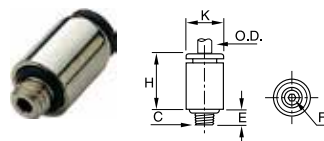

68LFR Male Connector Metric Straight Thread

PART NO.	TUBE SIZE	C UNF	E MM	F MM	H MM	K MM
68LFR-4M-M7	4	M7X1	4.6	3	14	9.95
68LFR-4M-M5	4	M5X0.8	3.5	2.5	14.5	8.50
68LFR-6M-M7	6	M7X1	4.6	3	16	9.90

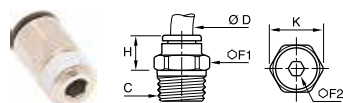

W68LF Male Connector BSPT

PART NO.	TUBE SIZE	C BSPT	F1 MM	F2 MM	H IN	K IN
W68LF-2-2R	1/8	1/8	10	2	.335	.433
W68LF-5/32-2R	5/32	1/8	10	3	.370	.430
W68LF-5/32-4R	5/32	1/4	14	3	.260	.590
W68LF-3-2R	3/16	1/8	11	3	.610	.510
W68LF-3-4R	3/16	1/4	14	3	.590	.650
W68LF-4-2R	1/4	1/8	11	4	.472	.472
W68LF-4-4R	1/4	1/4	14	4	.374	.591
W68LF-5-2R	5/16	1/8	13	5	.790	.550
W68LF-5-4R	5/16	1/4	14	6	.670	.590
W68LF-5-6R	5/16	3/8	17	6	.510	.730
W68LF-5-8R	5/16	1/2	21	6	.470	.910
W68LF-6-4R	3/8	1/4	16	7	.807	.689
W68LF-6-6R	3/8	3/8	17	7	.650	.728
W68LF-6-8R	3/8	1/2	21	7	.551	.906
W68LF-8-4R	1/2	1/4	22	6	1.060	.945
W68LF-8-6R	1/2	3/8	22	7	1.020	.945
W68LF-8-8R	1/2	1/2	24	7	.807	1.020

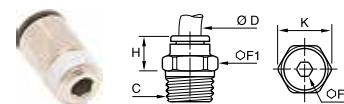

W68LF Male Connector Metric to NPT

PART NO.	TUBE SIZE (MM)	C NPT	F1 MM	F2 IN	H IN	K IN
W68LF-4M-2	4	1/8	11	3	.33	.47
W68LF-4M-4	4	1/4	14	3	.28	.59
W68LF-6M-2	6	1/8	11	4	.45	.47
W68LF-6M-4	6	1/4	14	4	.33	.59
W68LF-8M-2	8	1/8	13	5	.79	.55
W68LF-8M-4	8	1/4	14	6	.66	.59
W68LF-8M-6	8	3/8	18	6	.46	.77
W68LF-10M-4	10	1/4	16	7	.79	.69
W68LF-10M-6	10	3/8	18	8	.65	.77
W68LF-10M-8	10	1/2	22	8	.55	.95
W68LF-12M-6	12	3/8	19	9	.95	.83
W68LF-12M-8	12	1/2	22	10	.77	.95

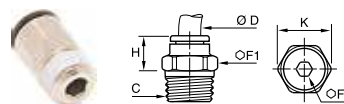

W68LF Male Connector Metric to BSPT

PART NO.	TUBE SIZE (MM)	C BSPT	F1 MM	F2 MM	H MM	K MM
W68LF-4M-2R	4	1/8	10	3	9.5	11.0
W68LF-4M-4R	4	1/4	14	3	6.5	15.0
W68LF-4M-6R	4	3/8	17	3	8.0	18.5
W68LF-6M-2R	6	1/8	11	4	11.5	11.0
W68LF-6M-4R	6	1/4	14	4	8.5	15.0
W68LF-6M-6R	6	3/8	17	4	8.5	18.5
W68LF-6M-8R	6	1/2	21	4	9.0	23.0
W68LF-8M-2R	8	1/8	13	5	20.0	14.0
W68LF-8M-4R	8	1/4	14	6	17.0	15.0
W68LF-8M-6R	8	3/8	17	6	13.0	18.5
W68LF-8M-8R	8	1/2	21	6	12.0	23.0
W68LF-10M-2R	10	1/8	16	5	22.5	17.5
W68LF-10M-4R	10	1/4	16	7	20.0	17.5
W68LF-10M-6R	10	3/8	17	8	16.5	18.5
W68LF-10M-8R	10	1/2	21	8	14.0	23.0
W68LF-12M-4R	12	1/4	19	7	26.5	21.0
W68LF-12M-6R	12	3/8	19	9	24.0	21.0
W68LF-12M-8R	12	1/2	21	9	19.5	23.0
W68LF-14M-6R	14	3/8	22	9	28.5	24.0
W68LF-14M-8R	14	1/2	24	10	23.5	26.0

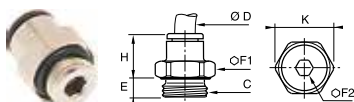

68LF Male Connector Metric to BSPP

PART NO.	TUBE SIZE (MM)	C BSPP	E MM	F1 MM	F2 MM	H MM	K MM
68LF-3M-M3	3	M3X0.5	2.50	8	-	12.5	8.5
68LF-3M-M5	3	M5X0.8	3.50	8	2.5	12.5	8.5
68LF-4M-M3	4	M3X0.5	2.50	8	-	14.5	8.5
68LF-4M-M5	4	M5X0.8	3.50	8	2.5	14.0	8.5
68LF-4M-M7	4	M7X1	5.00	10	2.5	14.0	11.0
68LF-4M-2G	4	1/8	4.50	13	3.0	11.5	14.0
68LF-4M-4G	4	1/4	5.50	16	3.0	10.5	17.5
68LF-6M-M5	6	M5X0.8	3.50	10	2.5	16.0	11.0
68LF-6M-M7	6	M7X1	5.00	10	3.0	16.0	11.0
68LF-6M-M10	6	M10X1	5.00	13	4.0	13.0	14.0
68LF-6M-M12	6	M12X1.5	5.50	15	4.0	13.0	16.0
68LF-6M-2G	6	1/8	4.50	13	4.0	13.0	14.0
68LF-6M-4G	6	1/4	5.50	16	4.0	12.5	17.5
68LF-6M-6G	6	3/8	5.50	20	4.0	13.0	22.0
68LF-6M-8G	6	1/2	7.50	24	4.0	20.0	26.0
68LF-8M-M10	8	M10X1	5.00	13	5.0	21.0	14.0
68LF-8M-M12	8	M12X1.5	5.50	15	5.0	21.0	16.0
68LF-8M-2G	8	1/8	4.50	13	5.0	20.5	14.0
68LF-8M-4G	8	1/4	5.50	16	6.0	19.5	17.5
68LF-8M-6G	8	3/8	5.50	20	6.0	18.0	22.0
68LF-8M-8G	8	1/2	7.50	24	6.0	16.5	26.0
68LF-10M-4G	10	1/4	5.50	16	7.0	23.0	17.5
68LF-10M-6G	10	3/8	5.50	20	8.0	19.5	22.0
68LF-10M-8G	10	1/2	7.50	24	8.0	18.5	26.0
68LF-12M-4G	12	1/4	5.50	19	7.0	27.5	21.0
68LF-12M-6G	12	3/8	5.50	20	9.0	27.0	22.0
68LF-12M-8G	12	1/2	7.00	24	10.0	22.5	26.0
68LF-14M-6G	14	3/8	5.50	22	9.0	29.5	24.0
68LF-14M-8G	14	1/2	7.00	24	11.0	28.0	26.0



W369PLP Male Elbow - NPT

PART NO.	TUBE SIZE (IN)	THREAD NPT / UNF	C HEX (MM)	L	H
369PLP-2-0	1/8	10-32	8	0.57	0.52
W369PLP-2-1	1/8	1/16	10	0.57	0.53
W369PLP-2-2	1/8	1/8	11	0.57	0.53
W369PLP-2-4	1/8	1/4	14	0.57	0.55
369PLP-4M-0	5/32 (4M)	10-32	8	0.55	0.53
W369PLP-4M-2	5/32 (4M)	1/8	11	0.55	0.53
W369PLP-4M-4	5/32 (4M)	1/4	14	0.55	0.55
W369PLP-3-2	3/16	1/8	11	0.85	0.67
369PLP-4-0	1/4	10-32	11	0.71	0.63
W369PLP-4-2	1/4	1/8	11	0.71	0.67
W369PLP-4-4	1/4	1/4	14	0.71	0.63
W369PLP-4-6	1/4	3/8	18	0.71	0.65
W369PLP-8M-2	5/16 (8M)	1/8	11	0.91	0.75
W369PLP-8M-4	5/16 (8M)	1/4	14	0.91	0.71
W369PLP-8M-6	5/16 (8M)	3/8	18	0.91	0.73
W369PLP-6-2	3/8	1/8	15	1.08	0.91
W369PLP-6-4	3/8	1/4	15	1.08	0.91
W369PLP-6-6	3/8	3/8	18	1.08	0.87
W369PLP-6-8	3/8	1/2	22	1.08	0.91
W369PLP-8-4	1/2	1/4	20	1.38	1.22
W369PLP-8-6	1/2	3/8	20	1.38	1.22
W369PLP-8-8	1/2	1/2	24	1.38	1.12

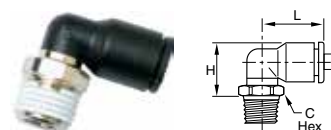

W369PLP Male Elbow - BSPT

PART NO.	TUBE SIZE (IN)	THREAD BSPT	C HEX (MM)	L	H
W369PLP-2-2R	1/8	1/8	10	0.57	0.53
W369PLP-4M-2R	5/32 (4M)	1/8	10	0.55	0.53
W369PLP-4M-4R	5/32 (4M)	1/4	14	0.55	0.55
W369PLP-3-2R	3/16	1/8	11	0.85	0.67
W369PLP-4-2R	1/4	1/8	10	0.71	0.67
W369PLP-4-4R	1/4	1/4	14	0.71	0.63
W369PLP-8M-2R	5/16 (8M)	1/8	10	0.91	0.75
W369PLP-8M-4R	5/16 (8M)	1/4	14	0.91	0.71
W369PLP-8M-6R	5/16 (8M)	3/8	17	0.91	0.71
W369PLP-8M-8R	5/16 (8M)	1/2	21	0.91	0.77
W369PLP-6-4R	3/8	1/4	15	1.04	0.87
W369PLP-6-6R	3/8	3/8	17	1.04	0.87
W369PLP-8-4R	1/2	1/4	20	1.38	1.22
W369PLP-8-6R	1/2	3/8	20	1.38	1.22
W369PLP-8-8R	1/2	1/2	24	1.38	1.12

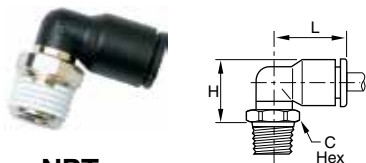

W369PLP Male Elbow - NPT

PART NO.	TUBE SIZE (MM)	THREAD NPT	C HEX (MM)	H	L
W369PLP-4M-2	4	1/8	11	.53	.55
W369PLP-4M-4	4	1/4	14	.55	.55
W369PLP-6M-2	6	1/8	11	.61	.63
W369PLP-6M-4	6	1/4	14	.63	.63
W369PLP-8M-2	8	1/8	11	.75	.91
W369PLP-8M-4	8	1/4	14	.71	.91
W369PLP-8M-6	8	3/8	18	.73	.91
W369PLP-10M-4	10	1/4	15	.91	1.04
W369PLP-10M-6	10	3/8	18	.87	1.04
W369PLP-10M-8	10	1/2	22	.91	1.04
W369PLP-12M-6	12	3/8	18	.98	1.22
W369PLP-12M-8	12	1/2	22	1.02	1.22

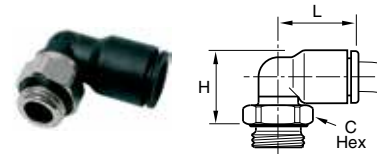

369PLP Male Elbow - BSPP

PART NO.	TUBE SIZE (MM)	BSPP / METRIC	C HEX (MM)	H	L
369PLP-3M-M3	3	M3X0.5	8	15.0	14.5
369PLP-3M-M5	3	M5X0.8	8	13.5	14.5
369PLP-4M-M3	4	M3X0.5	8	15.0	14.5
369PLP-4M-M5	4	M5X0.8	8	13.5	14.0
369PLP-4M-M7	4	M7X1	10	15.0	14.0
369PLP-4M-2G	4	1/8	13	13.0	14.0
369PLP-4M-4G	4	1/4	16	13.0	14.0
369PLP-6M-M5	6	M5X0.8	8	15.5	16.0
369PLP-6M-M7	6	M7X1	10	17.5	16.0
369PLP-6M-M10	6	M10X1	13	15.0	14.0
369PLP-6M-M12	6	M12X1.5	15	15.0	16.0
369PLP-6M-2G	6	1/8	13	15.0	16.0
369PLP-6M-4G	6	1/4	16	15.0	16.0
369PLP-6M-6G	6	3/8	20	15.5	16.0
369PLP-6M-8G	6	1/2	24	16.0	16.0
369PLP-8M-M10	8	M10X1	13	20.5	23.0
369PLP-8M-M12	8	M12X1.5	15	19.5	23.0
369PLP-8M-2G	8	1/8	13	20.5	23.0
369PLP-8M-4G	8	1/4	16	18.5	23.0
369PLP-8M-6G	8	3/8	20	18.5	23.0
369PLP-8M-8G	8	1/2	24	19.0	23.0
369PLP-10M-4G	10	1/4	16	23.5	26.5
369PLP-10M-6G	10	3/8	20	22.0	26.5
369PLP-10M-8G	10	1/2	24	22.0	26.5
369PLP-12M-4G	12	1/4	16	26.5	31.0
369PLP-12M-6G	12	3/8	20	25.0	31.0
369PLP-12M-8G	12	1/2	24	25.0	31.0
369PLP-14M-6G	14	3/8	20	32.5	35.5
369PLP-14M-8G	14	1/2	24	27.0	35.5
369PLP-16M-6G	16	3/8	27	54.5	39
369PLP-16M-8G	16	1/2	27	54.5	39

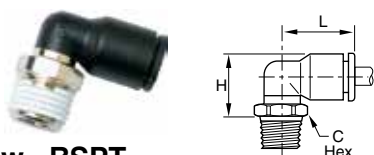

W369PLP Male Elbow - BSPT

PART NO.	TUBE SIZE (MM)	THREAD BSPT	C HEX (MM)	H	L
W369PLP-4M-2R	4	1/8	10	13.5	14.0
W369PLP-4M-4R	4	1/4	14	14.0	14.0
W369PLP-4M-6R	4	3/8	17	13.5	14.0
W369PLP-6M-2R	6	1/8	10	15.5	16.0
W369PLP-6M-4R	6	1/4	14	16.0	16.0
W369PLP-6M-6R	6	3/8	17	16.0	16.0
W369PLP-6M-8R	6	1/2	21	16.5	16.0
W369PLP-8M-2R	8	1/8	10	19.0	23.0
W369PLP-8M-4R	8	1/4	14	18.0	23.0
W369PLP-8M-6R	8	3/8	17	18.0	23.0
W369PLP-8M-8R	8	1/2	21	19.5	23.0
W369PLP-10M-2R	10	1/8	15	23.0	26.5
W369PLP-10M-4R	10	1/4	15	22.0	26.5
W369PLP-10M-6R	10	3/8	17	22.0	26.5
W369PLP-10M-8R	10	1/2	21	22.0	26.5
W369PLP-12M-4R	12	1/4	15	25.0	31.0
W369PLP-12M-6R	12	3/8	17	25.0	31.0
W369PLP-12M-8R	12	1/2	21	25.0	31.0
W369PLP-14M-6R	14	3/8	20	30.5	35.5
W369PLP-14M-8R	14	1/2	24	28.5	35.5
W369PLP-16M-6R	16	3/8	27	53	39.0
W369PLP-16M-8R	16	1/2	27	53	39.0

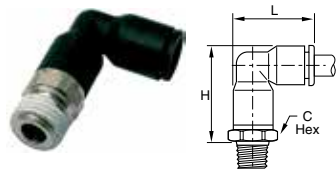

W369PLPX Extended Male Elbow - NPT

PART NO.	TUBE SIZE (IN)	THREAD NPT / UNF	C HEX (MM)	H	L
369PLPX-2-0	1/8	10-32	8	.91	.75
W369PLPX-2-2	1/8	1/8	11	.91	.75
W369PLPX-2-4	1/8	1/4	14	.93	.75
369PLPX-4M-0	5/32 (4M)	10-32	8	.91	.75
W369PLPX-4M-2	5/32 (4M)	1/8	11	.91	.75
W369PLPX-4M-4	5/32 (4M)	1/4	14	.93	.75
369PLPX-4-0	1/4	10-32	11	1.10	.93
369PLPX-4-M7	1/4	M7	9	1.17	.93
W369PLPX-4-2	1/4	1/8	11	1.12	.93
W369PLPX-4-4	1/4	1/4	14	1.08	.93
W369PLPX-4-6	1/4	3/8	17	1.12	.93
W369PLPX-8M-2	5/16 (8M)	1/8	13	1.32	1.16
W369PLPX-8M-4	5/16 (8M)	1/4	14	1.28	1.16
W369PLPX-6-2	3/8	1/8	17	1.40	1.34
W369PLPX-6-4	3/8	1/4	17	1.41	1.33
W369PLPX-6-6	3/8	3/8	18	1.45	1.33

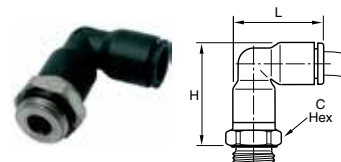

369PLPX Extended Male Elbow - BSPP

PART NO.	TUBE SIZE (MM)	BSPP / METRIC	C HEX (MM)	H
369PLPX-4M-M5	4	M5X0.8	8	23.0
369PLPX-4M-M7	4	M7X1	10	22.5
369PLPX-4M-2G	4	1/8	13	22.5
369PLPX-4M-4G	4	1/4	16	22.5
369PLPX-6M-M5	6	M5X0.8	10	27.5
369PLPX-6M-M7	6	M7X1	10	26.0
369PLPX-6M-2G	6	1/8	13	27.0
369PLPX-6M-4G	6	1/4	16	27.0
369PLPX-8M-2G	8	1/8	13	36.0
369PLPX-8M-4G	8	1/4	16	33.0
369PLPX-8M-6G	8	3/8	20	33.0
369PLPX-10M-4G	10	1/4	16	40.5
369PLPX-10M-6G	10	3/8	20	40.5
369PLPX-10M-8G	10	1/2	24	40.5
369PLPX-12M-4G	12	1/4	19	44.5
369PLPX-12M-6G	12	3/8	20	42.0
369PLPX-12M-8G	12	1/2	24	42.0
369PLPX-14M-6G	14	3/8	22	51.0
369PLPX-14M-8G	14	1/2	24	48.5

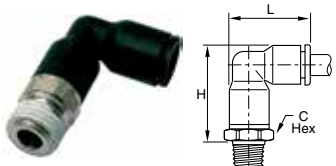

W369PLPX Extended Male Elbow - BSPT

PART NO.	TUBE SIZE (MM)	THREAD BSPT	C HEX (MM)	H	L
W369PLPX-4M-2R	4	1/8	10	23.0	19.0
W369PLPX-4M-4R	4	1/4	14	23.5	19.0
W369PLPX-6M-2R	6	1/8	10	27.0	22.5
W369PLPX-6M-4R	6	1/4	14	27.5	22.5
W369PLPX-8M-2R	8	1/8	13	34.5	29.5
W369PLPX-8M-4R	8	1/4	14	32.5	29.5
W369PLPX-8M-6R	8	3/8	17	33.0	29.5
W369PLPX-10M-4R	10	1/4	15	39.5	34.5
W369PLPX-10M-6R	10	3/8	17	39.5	34.5
W369PLPX-10M-8R	10	1/2	21	39.5	34.5
W369PLPX-12M-4R	12	1/4	19	45.5	40.5
W369PLPX-12M-6R	12	3/8	19	45.5	40.5
W369PLPX-12M-8R	12	1/2	21	45.5	40.5
W369PLPX-14M-6R	14	3/8	21	51.5	46.5
W369PLPX-14M-8R	14	1/2	21	51.5	46.5



W379PLP Male Elbow 45° - NPT

PART NO.	TUBE SIZE (IN)	THREAD NPT / UNF	C HEX (MM)	H	L
379PLP-2-0	1/8	10-32	8	.91	.49
W379PLP-2-2	1/8	1/8	11	.81	.49
W379PLP-4-2	1/4	1/8	11	.98	.57
W379PLP-4-4	1/4	1/4	14	.98	.57
W379PLP-4-M7	1/4	M7	9	1.14	.57
W379PLP-6-4	3/8	1/4	17	1.36	.91
W379PLP-6-6	3/8	3/8	18	1.36	.91



W379PLP 45° Male Elbow - BSPT

PART NO.	TUBE SIZE (MM)	BSPT	C HEX (MM)	H	L
W379PLP-4M-2R	4	1/8	10	24.5	13.0
W379PLP-6M-2R	6	1/8	10	28.0	14.5
W379PLP-6M-4R	6	1/4	14	30.0	14.5
W379PLP-8M-2R	8	1/8	10	33.5	19.5
W379PLP-8M-4R	8	1/4	14	33.5	19.5
W379PLP-8M-6R	8	3/8	17	33.5	19.5
W379PLP-10M-4R	10	1/4	15	38.5	23.0
W379PLP-10M-6R	10	3/8	17	39.0	23.0
W379PLP-10M-8R	10	1/2	21	40.5	23.0
W379PLP-12M-4R	12	1/4	15	44.0	26.0
W379PLP-12M-6R	12	3/8	17	44.0	26.0
W379PLP-12M-8R	12	1/2	21	46.0	26.0

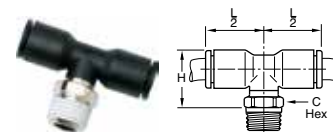

W372PLP Male Branch Tee - NPT

PART NO.	TUBE SIZE (IN)	THREAD NPT / UNF	C HEX (MM)	L/2	H
372PLP-2-0	1/8	10-32	8	.57	.61
W372PLP-2-1	1/8	1/16	10	.57	.61
W372PLP-2-2	1/8	1/8	11	.57	.61
W372PLP-2-4	1/8	1/4	14	.57	.63
372PLP-4M-0	5/32 (4M)	10-32	8	.55	.71
W372PLP-4M-4	5/32 (4M)	1/4	14	.55	.63
W372PLP-3-2	3/16	1/8	11	.85	.67
W372PLP-4-2	1/4	1/8	11	.71	.67
W372PLP-4-4	1/4	1/4	14	.71	.63
W372PLP-4-6	1/4	3/8	18	.71	.65
W372PLP-5-2	5/16	1/8	11	.91	.87
W372PLP-5-4	5/16	1/4	14	.91	.83
W372PLP-5-6	5/16	3/8	18	.91	.85
W372PLP-6-2	3/8	1/8	15	1.04	.99
W372PLP-6-4	3/8	1/4	15	1.04	.99
W372PLP-6-6	3/8	3/8	18	1.04	.95
W372PLP-6-8	3/8	1/2	22	1.04	.98
W372PLP-8-4	1/2	1/4	20	1.38	1.22
W372PLP-8-6	1/2	3/8	20	1.38	1.22
W372PLP-8-8	1/2	1/2	24	1.38	1.21

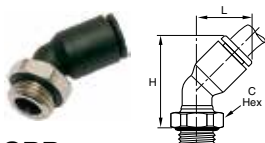

379PLP 45° Male Elbow - BSPP

PART NO.	TUBE SIZE (MM)	BSPP / M5	C HEX (MM)	H	L
379PLP-4M-M5	4	M5X0.8	8	23.0	13.0
379PLP-4M-2G	4	1/8	13	25.0	13.0
379PLP-6M-M5	6	M5X0.8	8	30.0	14.5
379PLP-6M-2G	6	1/8	13	28.5	14.5
379PLP-6M-4G	6	1/4	16	29.5	14.5
379PLP-8M-2G	8	1/8	13	36.0	19.5
379PLP-8M-4G	8	1/4	16	34.5	19.5
379PLP-8M-6G	8	3/8	20	34.5	19.5
379PLP-10M-4G	10	1/4	16	40.5	23.0
379PLP-10M-6G	10	3/8	20	39.0	23.0
379PLP-10M-8G	10	1/2	24	41.0	23.0
379PLP-12M-4G	12	1/4	16	46.0	26.0
379PLP-12M-6G	12	3/8	20	44.5	26.0
379PLP-12M-8G	12	1/2	24	46.0	26.0

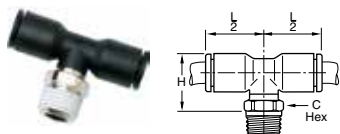

W372PLP Male Branch Tee - BSPT

PART NO.	TUBE SIZE (IN)	THREAD BSPT	C HEX (MM)	L/2	H
W372PLP-2-2R	1/8	1/8	10	.55	.61
W372PLP-4M-2R	5/32 (4M)	1/8	10	.55	.61
W372PLP-4M-4R	5/32 (4M)	1/4	14	.55	.63
W372PLP-3-2R	3/16	1/8	11	.85	.67
W372PLP-3-4R	3/16	1/4	14	.85	.67
W372PLP-4-2R	1/4	1/8	10	.71	.67
W372PLP-4-4R	1/4	1/4	14	.71	.63
W372PLP-8M-2R	5/16 (8M)	1/8	10	.91	.87
W372PLP-8M-4R	5/16 (8M)	1/4	14	.91	.83
W372PLP-8M-6R	5/16 (8M)	3/8	17	.91	.83
W372PLP-6-4R	3/8	1/4	15	1.04	.95
W372PLP-6-6R	3/8	3/8	17	1.04	.95
W372PLP-8-4R	1/2	1/4	20	1.38	1.24
W372PLP-8-6R	1/2	3/8	20	1.38	1.22

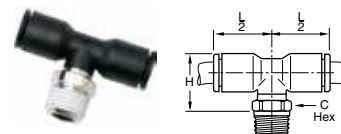

W372PLP Male Branch Tee - BSPT

PART NO.	TUBE SIZE (MM)	BSPT	C HEX (MM)	H	L/2
W372PLP-4M-2R	4	1/8	10	15.5	14.0
W372PLP-4M-4R	4	1/4	14	16.0	14.0
W372PLP-6M-2R	6	1/8	10	17.5	16.0
W372PLP-6M-4R	6	1/4	14	18.0	16.0
W372PLP-8M-2R	8	1/8	10	22.0	23.0
W372PLP-8M-4R	8	1/4	14	21.0	23.0
W372PLP-8M-6R	8	3/8	17	21.0	23.0
W372PLP-10M-4R	10	1/4	15	24.0	26.5
W372PLP-10M-6R	10	3/8	17	24.0	26.5
W372PLP-10M-8R	10	1/2	21	24.0	26.5
W372PLP-12M-4R	12	1/4	15	27.0	31.0
W372PLP-12M-6R	12	3/8	17	27.0	31.0
W372PLP-12M-8R	12	1/2	21	27.0	31.0
W372PLP-14M-6R	14	3/8	20	30.5	35.5
W372PLP-14M-8R	14	1/2	24	28.5	35.5
W372PLP-16M-6R	16	3/8	27	53.0	38.5
W372PLP-16M-8R	16	1/2	27	53.0	38.5

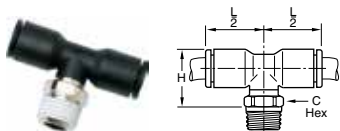

W372PLP Male Branch Tee - NPT

PART NO.	TUBE SIZE (MM)	NPT	C HEX (MM)	H	L/2
W372PLP-4M-2	4	1/8	11	.61	.55
W372PLP-4M-4	4	1/4	14	.63	.55
W372PLP-6M-2	6	1/8	11	.69	.63
W372PLP-6M-4	6	1/4	14	.71	.63
W372PLP-8M-2	8	1/8	11	.87	.91
W372PLP-8M-4	8	1/4	14	.83	.91
W372PLP-8M-6	8	3/8	18	.85	.91
W372PLP-10M-4	10	1/4	15	.98	1.04
W372PLP-10M-6	10	3/8	18	.95	1.04
W372PLP-10M-8	10	1/2	22	.98	1.04
W372PLP-12M-6	12	3/8	18	1.06	1.22
W372PLP-12M-8	12	1/2	22	.98	1.22

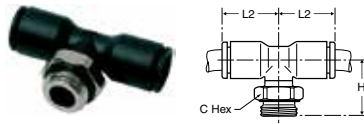

372PLP Male Branch Tee - BSPP

PART NO.	TUBE SIZE (MM)	BSPP / M5	C HEX (MM)	H	L/2
372PLP-4M-M5	4	M5X0.8	8	17.5	14.0
372PLP-4M-2G	4	1/8	13	15.0	14.0
372PLP-4M-4G	4	1/4	16	15.0	14.0
372PLP-6M-M5	6	M5X0.8	8	19.5	16.0
372PLP-6M-2G	6	1/8	13	17.0	16.0
372PLP-6M-4G	6	1/4	16	17.0	16.0
372PLP-8M-2G	8	1/8	13	23.5	23.0
372PLP-8M-4G	8	1/4	16	21.5	23.0
372PLP-8M-6G	8	3/8	20	21.5	23.0
372PLP-10M-4G	10	1/4	16	26.0	26.5
372PLP-10M-6G	10	3/8	20	24.0	26.5
372PLP-10M-8G	10	1/2	24	24.0	26.5
372PLP-12M-4G	12	1/4	16	29.0	31.0
372PLP-12M-6G	12	3/8	20	27.0	31.0
372PLP-12M-8G	12	1/2	24	27.0	31.0
372PLP-14M-6G	14	3/8	20	32.5	35.5
372PLP-14M-8G	14	1/2	24	27.0	35.5
372PLP-16M-6G	16	3/8	27	54.5	38.5
372PLP-16M-8G	16	1/2	27	54.5	38.5

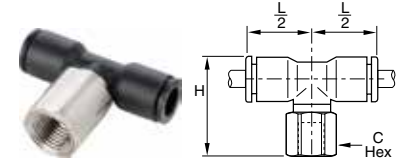

377PLP Female Branch Tee - NPT

PART NO.	TUBE SIZE (IN)	THREAD NPT / UNF	C HEX (MM)	L/2	H
377PLP-2-2	1/8	1/8	13	.57	.99
377PLP-4M-2	5/32 (4M)	1/8	13	.55	.91
377PLP-4M-4	5/32 (4M)	1/4	16	.55	1.08
377PLP-4-2	1/4	1/8	13	.71	1.02
377PLP-4-4	1/4	1/4	16	.71	1.18
377PLP-8M-2	5/16 (8M)	1/8	13	.91	1.24
377PLP-8M-4	5/16 (8M)	1/4	16	.91	1.40
377PLP-6-4	3/8	1/4	16	1.04	1.60
377PLP-8-6	1/2	3/8	22	1.38	1.88

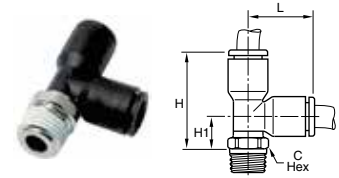

W371PLP Male Run Tee - NPT

PART NO.	TUBE SIZE (IN)	THREAD NPT / UNF	C HEX (MM)	L	H	H1
371PLP-2-0	1/8	10-32	8	.57	.92	.35
W371PLP-2-1	1/8	1/16	10	.57	.93	.35
W371PLP-2-2	1/8	1/8	11	.57	.93	.35
371PLP-4M-0	5/32 (4M)	10-32	8	.57	1.02	.45
W371PLP-4M-2	5/32 (4M)	1/8	11	.57	.93	.53
W371PLP-4M-4	5/32 (4M)	1/4	14	.57	.94	.37
W371PLP-3-2	3/16	1/8	11	.85	1.31	.45
W371PLP-4-2	1/4	1/8	11	.69	1.16	.45
W371PLP-4-4	1/4	1/4	14	.69	1.12	.41
W371PLP-4-6	1/4	3/8	18	.69	1.14	.43
W371PLP-8M-2	5/16 (8M)	1/8	11	.91	1.38	.49
W371PLP-8M-4	5/16 (8M)	1/4	14	.91	1.34	.45
W371PLP-8M-6	5/16 (8M)	3/8	18	.91	1.36	.47
W371PLP-6-2	3/8	1/8	15	1.04	1.63	.60
W371PLP-6-4	3/8	1/4	15	1.04	1.63	.60
W371PLP-6-6	3/8	3/8	18	1.04	1.60	.55
W371PLP-6-8	3/8	1/2	22	1.04	1.63	.59
W371PLP-8-4	1/2	1/4	20	1.38	2.17	.79
W371PLP-8-6	1/2	3/8	20	1.38	2.17	.79
W371PLP-8-8	1/2	1/2	24	1.38	2.07	.79

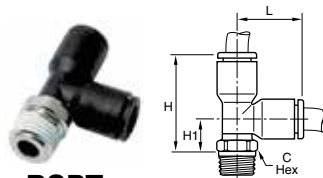

W371PLP Male Run Tee - BSPT

PART NO.	TUBE SIZE (MM)	THREAD BSPT	C HEX (MM)	H	H1	L
W371PLP-4M-2R	4	1/8	10	23.5	9.0	14.5
W371PLP-4M-4R	4	1/4	14	24.0	9.5	14.5
W371PLP-6M-2R	6	1/8	10	27.5	10.0	17.5
W371PLP-6M-4R	6	1/4	14	28.0	10.5	17.5
W371PLP-8M-2R	8	1/8	10	35.0	12.0	23.0
W371PLP-8M-4R	8	1/4	14	34.0	11.0	23.0
W371PLP-8M-6R	8	3/8	17	34.0	11.0	23.0
W371PLP-10M-4R	10	1/4	15	40.5	14.0	26.5
W371PLP-10M-6R	10	3/8	17	40.5	14.0	26.5
W371PLP-10M-8R	10	1/2	21	40.5	14.0	26.5
W371PLP-12M-4R	12	1/4	15	46.5	15.5	31.0
W371PLP-12M-6R	12	3/8	17	46.5	15.5	31.0
W371PLP-12M-8R	12	1/2	21	46.5	15.5	31.0
W371PLP-14M-6R	14	3/8	20	55.0	19.5	35.5
W371PLP-14M-8R	14	1/2	24	52.5	17.5	35.5
W371PLP-16M-6R	16	3/8	27	38.5	78	39.5
W371PLP-16M-8R	16	1/2	27	38.5	78	39.5

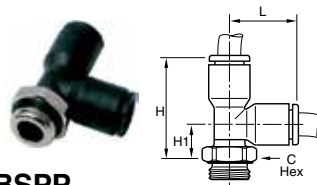

371PLP Male Run Tee - BSPP

PART NO.	TUBE SIZE (MM)	BSPP / M5	C HEX (MM)	H	H1	L
371PLP-4M-M5	4	M5X0.8	8	26.0	11.5	14.5
371PLP-4M-2G	4	1/8	13	23.0	8.5	14.5
371PLP-4M-4G	4	1/4	16	23.0	8.5	14.5
371PLP-6M-M5	6	M5X0.8	8	29.5	12.5	17.5
371PLP-6M-2G	6	1/8	13	27.0	10.0	17.5
371PLP-6M-4G	6	1/4	16	27.0	10.0	17.5
371PLP-8M-2G	8	1/8	13	36.5	14.0	23.0
371PLP-8M-4G	8	1/4	16	34.5	12.0	23.0
371PLP-8M-6G	8	3/8	20	34.5	12.0	23.0
371PLP-10M-4G	10	1/4	16	42.0	15.5	26.5
371PLP-10M-6G	10	3/8	20	40.5	14.0	26.5
371PLP-10M-8G	10	1/2	24	40.5	14.0	26.5
371PLP-12M-4G	12	1/4	16	48.0	17.0	31.0
371PLP-12M-6G	12	3/8	20	46.5	15.5	31.0
371PLP-12M-8G	12	1/2	24	46.5	15.5	31.0
371PLP-14M-6G	14	3/8	20	56.5	21.5	35.5
371PLP-14M-8G	14	1/2	24	51.0	16.0	35.5
371PLP-16M-6G	16	3/8	27	38.5	79.5	41
371PLP-16M-8G	16	1/2	27	38.5	79.5	41

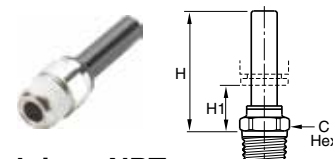

W68PLPSP Male Standpipe - NPT

PART NO.	TUBE SIZE (IN)	THREAD NPT / UNF	C HEX (MM)	H	H1
68PLPSP-4M-0	5/32 (4M)	10-32	8	1.24	
W68PLPSP-4M-2	5/32 (4M)	1/8	11	1.02	.57
W68PLPSP-4M-4	5/32 (4M)	1/4	14	1.04	.59
W68PLPSP-4-2	1/4	1/8	11	1.18	.61
W68PLPSP-4-4	1/4	1/4	14	1.12	.57
W68PLPSP-8M-2	5/16 (8M)	1/8	11	1.16	.43
W68PLPSP-8M-4	5/16 (8M)	1/4	14	1.12	.39
W68PLPSP-6-2	3/8	1/8	15	1.75	.65
W68PLPSP-6-4	3/8	1/4	15	1.42	.67
W68PLPSP-6-6	3/8	3/8	17	1.42	.61
W68PLPSP-8-6	1/2	3/8	17	1.44	.37
W68PLPSP-8-8	1/2	1/2	21	1.46	.39

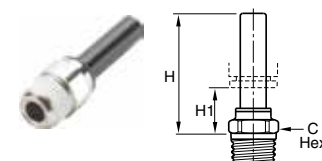

W68PLPSP Male Standpipe - BSPT

PART NO.	TUBE SIZE (MM)	BSPT	C HEX (MM)	H	H1
W68PLPSP-4M-2R	4	1/8	10	26.0	14.0
W68PLPSP-4M-4R	4	1/4	14	26.5	14.5
W68PLPSP-6M-2R	6	1/8	10	28.0	14.0
W68PLPSP-6M-4R	6	1/4	14	28.5	14.5
W68PLPSP-8M-2R	8	1/8	10	29.5	11.0
W68PLPSP-8M-4R	8	1/4	14	28.5	10.0
W68PLPSP-8M-6R	8	3/8	17	28.5	10.0
W68PLPSP-10M-4R	10	1/4	15	36.0	15.5
W68PLPSP-10M-6R	10	3/8	17	36.0	15.5
W68PLPSP-10M-8R	10	1/2	21	36.0	15.5
W68PLPSP-12M-6R	12	3/8	17	36.5	12.0
W68PLPSP-12M-8R	12	1/2	21	36.5	12.0
W68PLPSP-14M-8R	14	1/2	21	41.0	13.5

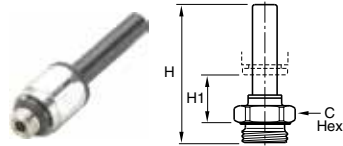

68PLPSP Male Standpipe - BSPP

PART NO.	TUBE SIZE (MM)	BSPP	C HEX (MM)	H	H1
68PLPSP-4M-M5	4	M5X0.8	8	31.0	16.0
68PLPSP-4M-2G	4	1/8	13	30.0	13.5
68PLPSP-4M-4G	4	1/4	16	31.0	13.5
68PLPSP-6M-2G	6	1/8	13	32.0	13.5
68PLPSP-6M-4G	6	1/4	16	33.0	13.5
68PLPSP-8M-2G	8	1/8	13	35.5	12.5
68PLPSP-8M-4G	8	1/4	16	34.5	10.5
68PLPSP-8M-6G	8	3/8	20	34.5	10.5
68PLPSP-10M-4G	10	1/4	16	43.5	17.5
68PLPSP-10M-6G	10	3/8	20	41.5	15.5
68PLPSP-10M-8G	10	1/2	24	41.5	15.5
68PLPSP-12M-6G	12	3/8	20	42.0	12.0
68PLPSP-12M-8G	12	1/2	24	43.5	12.0
68PLPSP-14M-6G	14	3/8	20	46.5	14.0
68PLPSP-14M-8G	14	1/2	24	48.0	13.5

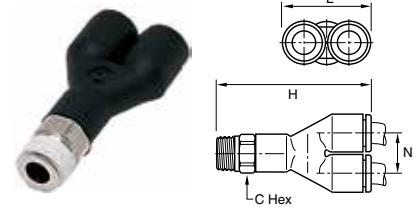

W368PLP Male Y Connector - BSPT

PART NO.	TUBE SIZE (MM)	BSPT	C HEX (MM)	H	L	N
W368PLP-4M-2R	4	1/8	10	32.5	17.5	9.0
W368PLP-4M-4R	4	1/4	14	33.0	17.5	9.0
W368PLP-6M-2R	6	1/8	10	39.5	21.5	1.0
W368PLP-6M-4R	6	1/4	14	40.0	21.5	1.0
W368PLP-8M-2R	8	1/8	13	56.5	28.0	14.5
W368PLP-8M-4R	8	1/4	14	55.5	28.0	14.5
W368PLP-8M-6R	8	3/8	16	48.5	28.0	14.5
W368PLP-10M-4R	10	1/4	14	60.0	39.0	20.0
W368PLP-10M-6R	10	3/8	16	60.5	39.0	20.0
W368PLP-10M-8R	10	1/2	24	61.0	39.0	20.0
W368PLP-12M-6R	12	3/8	19	66.0	39.0	20.0
W368PLP-12M-8R	12	1/2	21	66.0	39.0	20.0



W368PLP Male Y Connector - NPT

PART NO.	TUBE SIZE (IN)	THREAD NPT	C HEX (MM)	H	L	N
W368PLP-4M-2	5/32 (4M)	1/8	11	1.28	.69	.35
W368PLP-4M-4	5/32 (4M)	1/4	14	1.30	.69	.35
W368PLP-4-2	1/4	1/8	11	1.61	.87	.45
W368PLP-4-4	1/4	1/4	14	1.56	.87	.45
W368PLP-6-4	3/8	1/4	17	2.24	1.30	.67
W368PLP-6-6	3/8	3/8	18	2.28	1.30	.67



368PLP Male Y Connector - BSPP

PART NO.	TUBE SIZE (MM)	BSPP / M5	C HEX (MM)	H	L	N
368PLP-4M-M5	4	M5X0.8	8	32.5	17.5	9.0
368PLP-4M-2G	4	1/8	13	32.0	17.5	9.0
368PLP-4M-4G	4	1/4	16	32.0	17.5	9.0
368PLP-6M-M5	6	M5X0.8	10	39.5	21.5	11.0
368PLP-6M-2G	6	1/8	13	39.0	21.5	11.0
368PLP-6M-4G	6	1/4	16	39.0	21.5	11.0
368PLP-8M-2G	8	1/8	13	56.0	28.0	14.5
368PLP-8M-4G	8	1/4	16	55.0	28.0	14.5
368PLP-8M-6G	8	3/8	19	54.0	28.0	14.5
368PLP-10M-4G	10	1/4	16	63.5	33.0	17.0
368PLP-10M-6G	10	3/8	20	63.5	33.0	17.0
368PLP-10M-8G	10	1/2	20	65.0	33.0	17.0
368PLP-12M-6G	12	3/8	19	68.0	39.0	20.0
368PLP-12M-8G	12	1/2	24	70.0	39.0	20.0

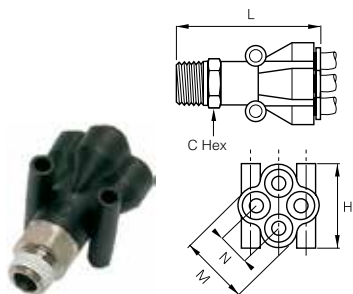

W368PLPD Double Y Male Connector - BSPT

PART NO.	TUBE SIZE (MM)	BSPT	C HEX (MM)	H	L	M	N	MOUNTING HOLE DIA
W368PLPD-4M-2R	4	1/8	13	25.5	41.5	21.0	10.0	3.7
W368PLPD-4M-4R	4	1/4	14	25.5	43.5	21.0	10.0	3.7
W368PLPD-6M-2R	6	1/8	19	31.5	54.5	26.5	12.0	3.7
W368PLPD-6M-4R	6	1/4	19	31.5	57.5	26.5	12.0	3.7

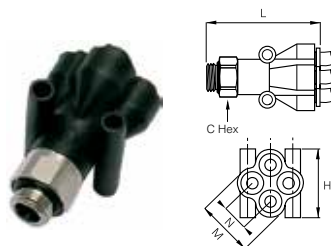

368PLPD Double Y Male Connector - BSPP

PART NO.	TUBE SIZE (MM)	BSPP	C HEX (MM)	H	L	M	N	MOUNTING HOLE DIA
368PLPD-4M-2G	4	1/8	13	25.5	41.0	21.0	10.0	3.7
368PLPD-4M-4G	4	1/4	16	25.5	40.0	21.0	10.0	3.7
368PLPD-6M-2G	6	1/8	19	31.5	52.5	26.5	12.0	3.7
368PLPD-6M-4G	6	1/4	19	31.5	53.5	26.5	12.0	3.7

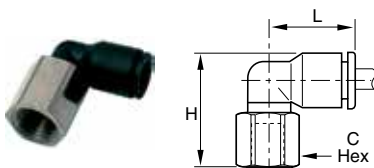

370PLP Female Elbow Swivel - NPT

PART NO.	TUBE SIZE (IN)	THREAD NPT	C HEX (MM)	L	H
370PLP-2-2	1/8	1/8	13	.57	.91
370PLP-4M-2	5/32 (4M)	1/8	13	.55	.91
370PLP-4M-4	5/32 (4M)	1/4	16	.55	1.08
370PLP-4-2	1/4	1/8	13	.71	1.02
370PLP-4-4	1/4	1/4	16	.71	1.18
370PLP-8M-2	5/16 (8M)	1/8	13	.91	1.12
370PLP-8M-4	5/16 (8M)	1/4	16	.91	1.28
370PLP-6-2	3/8	1/8	16	1.04	1.52
370PLP-6-4	3/8	1/4	16	1.04	1.52
370PLP-8-6	1/2	3/8	22	1.38	1.88

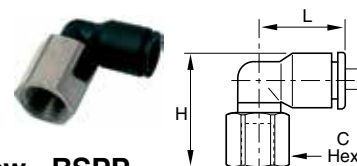

370PLP Female Elbow - BSPP

PART NO.	TUBE SIZE (MM)	BSPP	C HEX (MM)	H	L
370PLP-4M-2G	4	1/8	13	23.0	14.0
370PLP-4M-4G	4	1/4	16	27.0	14.0
370PLP-6M-2G	6	1/8	13	25.0	16.0
370PLP-6M-4G	6	1/4	16	29.0	16.0
370PLP-8M-2G	8	1/8	13	28.0	23.0
370PLP-8M-4G	8	1/4	16	32.0	23.0
370PLP-8M-6G	8	3/8	19	33.0	23.0
370PLP-10M-4G	10	1/4	16	34.5	26.5
370PLP-10M-6G	10	3/8	19	35.0	26.5
370PLP-10M-8G	10	1/2	24	41.0	26.5
370PLP-12M-4G	12	1/4	16	38.0	30.5
370PLP-12M-6G	12	3/8	19	38.5	30.5
370PLP-12M-8G	12	1/2	24	43.5	30.5

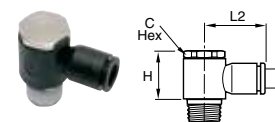

W369PLPBJ Banjo - NPT

PART NO.	TUBE SIZE (IN)	THREAD NPT / UNF	C HEX (MM)	H	L2
369PLPBJ-2-0	1/8	10-32		.79	.65
369PLPBJ-4M-0	5/32 (4M)	10-32		.79	.65
W369PLPBJ-4M-2	5/32 (4M)	1/8	13	.73	.73
369PLPBJ-4-0	1/4	10-32		.79	.73
W369PLPBJ-4-2	1/4	1/8	13	.73	.83
W369PLPBJ-4-4	1/4	1/4	17	.89	.91
W369PLPBJ-4-6	1/4	3/8	21	1.04	1.12
W369PLPBJ-6-4	3/8	1/4	17	.89	1.12
W369PLPBJ-6-6	3/8	3/8	21	1.04	1.20

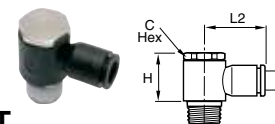

W369PLPBJ Banjo - BSPT

PART NO.	TUBE SIZE (MM)	BSPT	C HEX (MM)	H	L2
W369PLPBJ-4M-2R	4	1/8	13	18.5	18.5
W369PLPBJ-6M-2R	6	1/8	13	18.5	20.0
W369PLPBJ-6M-4R	6	1/4	17	22.5	22.0
W369PLPBJ-8M-2R	8	1/8	13	18.5	25.0
W369PLPBJ-8M-4R	8	1/4	17	22.5	27.0
W369PLPBJ-8M-6R	8	3/8	21	26.5	29.0
W369PLPBJ-10M-4R	10	1/4	17	22.5	29.0
W369PLPBJ-10M-6R	10	3/8	21	26.5	31.0
W369PLPBJ-12M-4R	12	1/4	21	26.5	34.5
W369PLPBJ-12M-6R	12	3/8	21	26.5	34.5
W369PLPBJ-12M-8R	12	1/2	25	30.0	37.0

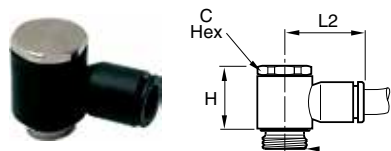

369PLPBJ Banjo - BSPP

PART NO.	TUBE SIZE (MM)	BSPP / METRIC	C HEX (MM)	H	L2
369PLPBJ-3M-M3*	3	M3X0.5		13.0	16.0
369PLPBJ-3M-M5*	3	M5X0.8		13.0	16.0
369PLPBJ-4M-M5*	4	M5X0.8		13.0	16.0
369PLPBJ-4M-2G	4	1/8	13	17.0	18.5
369PLPBJ-6M-M5*	6	M5X0.8		13.0	18.5
369PLPBJ-6M-2G	6	1/8	13	17.0	20.0
369PLPBJ-6M-4G	6	1/4	17	21.0	22.0
369PLPBJ-8M-2G	8	1/8	13	16.5	25.0
369PLPBJ-8M-4G	8	1/4	17	21.0	27.0
369PLPBJ-8M-6G	8	3/8	20	24.5	29.0
369PLPBJ-10M-4G	10	1/4	17	21.0	29.0
369PLPBJ-10M-6G	10	3/8	20	24.5	31.0
369PLPBJ-10M-8G	10	1/2	25	27.5	36.5
369PLPBJ-12M-6G	12	3/8	20	24.5	34.5
369PLPBJ-12M-8G	12	1/2	25	27.5	36.5

*With screwdriver slot

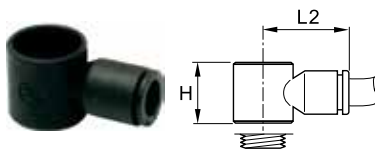

369PLPBJB Banjo Bodies

PART NO.	TUBE SIZE (MM)	BSPP / M5	H	L2
369PLPBJB-3M-M5	3	M5X0.8	13.0	16.0
369PLPBJB-4M-M5	4	M5X0.8	13.0	16.0
369PLPBJB-4M-2G	4	1/8	14.5	18.5
369PLPBJB-6M-M5	6	M5X0.8	13.0	18.5
369PLPBJB-6M-2G	6	1/8	14.5	20.0
369PLPBJB-6M-4G	6	1/4	18.0	22.0
369PLPBJB-8M-2G	8	1/8	14.5	25.0
369PLPBJB-8M-4G	8	1/4	18.0	27.0
369PLPBJB-8M-6G	8	3/8	21.5	29.0
369PLPBJB-10M-4G	10	1/4	18.0	29.0
369PLPBJB-10M-6G	10	3/8	21.5	31.0
369PLPBJB-10M-8G	10	1/2	22.5	36.5
369PLPBJB-12M-6G	12	3/8	21.5	34.5
369PLPBJB-12M-8G	12	1/2	22.5	36.5

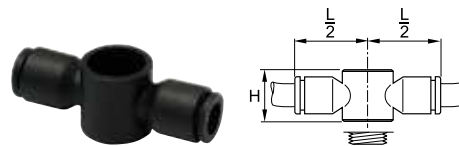

32PLPDJB Double Banjo Bodies

PART NO.	TUBE SIZE (MM)	BSPP / M5	H	L/2
32PLPDJB-4M-M5	4	M5X0.8	13.0	16.0
32PLPDJB-4M-2G	4	1/8	14.4	20.0
32PLPDJB-6M-2G	6	1/8	14.4	20.0
32PLPDJB-6M-4G	6	1/4	18.0	26.0
32PLPDJB-8M-4G	8	1/4	18.0	27.0
32PLPDJB-8M-6G	8	3/8	21.5	30.5
32PLPDJB-10M-6G	10	3/8	21.5	31.0

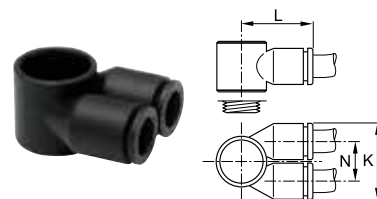

369PLPTJB Twin Banjo Bodies

PART NO.	TUBE SIZE (MM)	BSPP / M5	K	L	N
369PLPTJB-4M-M5	4	M5X0.8	17.5	15.5	9.0
369PLPTJB-4M-2G	4	1/8	22.5	20.0	12.0
369PLPTJB-4M-4G	4	1/4	28.0	25.0	14.5
369PLPTJB-6M-2G	6	1/8	22.5	20.5	12.0
369PLPTJB-6M-4G	6	1/4	28.0	25.0	14.5
369PLPTJB-6M-6G	6	3/8	33.0	28.5	17.0
369PLPTJB-8M-4G	8	1/4	28.0	26.0	14.5
369PLPTJB-8M-6G	8	3/8	33.0	29.5	17.0
369PLPTJB-10M-6G	10	3/8	33.0	29.5	17.0

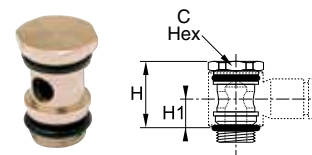

68BJB Single Banjo Bolt

PART NO.	BSPP / M5	C HEX (MM)	H	H1
68BJB-M5*	M5X0.8		17.0	7.5
68BJB-2G	1/8	13	17.0	7.5
68BJB-4G	1/4	17	21.0	9.5
68BJB-6G	3/8	20	24.5	11.0
68BJB-8G	1/2	25	27.5	11.5

*With screwdriver slot

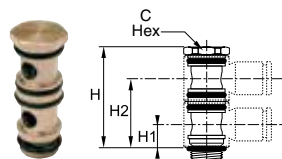

68BJBD Double Banjo Bolt

PART NO.	BSPP / M5	C HEX (MM)	H	H1	H2
68BJBD-M5*	M5X0.8		24.5	7.5	18.5
68BJBD-2G	1/8	13	31.0	7.5	22.0
68BJBD-4G	1/4	17	39.0	9.5	27.5
68BJBD-6G	3/8	20	46.0	11.0	32.5

*With screwdriver slot

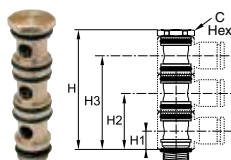

68BJBT Triple Banjo Bolt

PART NO.	BSPP	C HEX (MM)	H	H1	H2	H3
68BJBT-2G	1/8	13	45.5	7.5	22.0	36.0
68BJBT-4G	1/4	17	54.0	9.5	27.5	45.5
68BJBT-6G	3/8	20	67.5	11.0	32.5	54.0

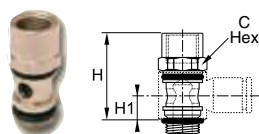

66BJB Female Threaded Banjo Bolt

PART NO.	1 BSPP / M5	2 BSPP / M5	C HEX (MM)	H	H1
66BJB-M5*	M5X0.8	M5X0.8	8	17.0	7.5
66BJB-2G	1/8	1/8	13	24.5	7.5
66BJB-4G	1/4	1/4	17	33.0	9.5
66BJB-6G	3/8	3/8	20	37.5	11.0
66BJB-8G	1/2	1/2	25	42.0	11.5

*With screwdriver slot

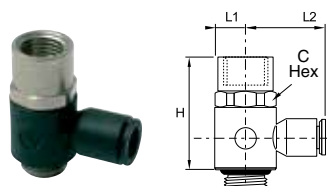

376PLPBJ Banjo with Female Bolt

PART NO.	TUBE SIZE (MM)	BSPP / M5	C HEX (MM)	H	L1	L2
376PLPBJ-4M-M5	4	M5X0.8	8	19.0	5.0	16.0
376PLPBJ-4M-2G	4	1/8	13	25.5	7.0	18.5
376PLPBJ-6M-4G	6	1/4	17	33.0	9.0	22.0
376PLPBJ-8M-6G	8	3/8	20	37.5	11	29.0

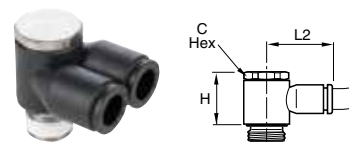

W369PLPTJ Twin Banjo - NPT

PART NO.	TUBE SIZE (IN)	THREAD NPT / UNF	C HEX (MM)	H	L2
369PLPTJ-4M-0	5/32 (4M)	10-32		.63	.61
W369PLPTJ-4M-2	5/32 (4M)	1/8	13	.73	.73
W369PLPTJ-4-2	1/4	1/8	13	.73	.73
W369PLPTJ-4-4	1/4	1/4	17	.89	1.04
W369PLPTJ-6-4	3/8	1/4	21	1.04	1.22
W369PLPTJ-6-6	3/8	3/8	21	1.04	1.22

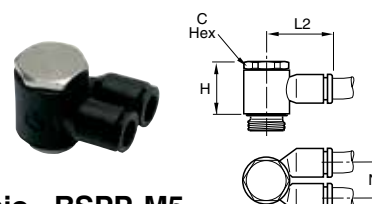

369PLPTJ Twin Banjo - BSPP, M5

PART NO.	TUBE SIZE (MM)	BSPP / M5	C HEX (MM)	H	L2	N
369PLPTJ-4M-M5	4	M5X0.8		13.0	16.0	9.0
369PLPTJ-4M-2G	4	1/8	13	16.5	18.5	11.5
369PLPTJ-6M-2G	6	1/8	13	16.5	18.5	11.5
369PLPTJ-6M-4G	6	1/4	17	21.0	27.0	14.5
369PLPTJ-8M-4G	8	1/4	17	21.0	27.0	14.5
369PLPTJ-8M-6G	8	3/8	20	24.5	31.0	17.0
369PLPTJ-10M-6G	10	3/8	20	24.5	31.0	17.0

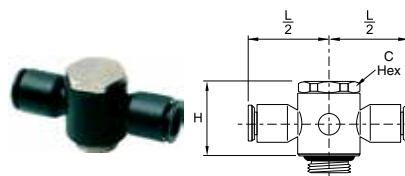

32PLPDJ Double Banjo - BSPP, M5

PART NO.	TUBE SIZE (MM)	BSPP / M5	C HEX (MM)	H	L/2
32PLPDJ-4M-M5	4	M5X0.8		13.0	16.0
32PLPDJ-4M-2G	4	1/8	13	17.0	20.0
32PLPDJ-6M-2G	6	1/8	13	17.0	20.0
32PLPDJ-6M-4G	6	1/4	17	21.0	26.5
32PLPDJ-8M-4G	8	1/4	17	21.0	27.0
32PLPDJ-8M-6G	8	3/8	20	24.5	30.5
32PLPDJ-10M-6G	10	3/8	20	24.5	31.0

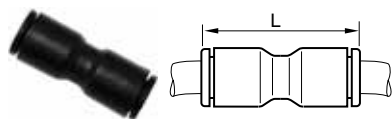

32PLP Equal Union

PART NO.	TUBE SIZE (IN)	L
32PLP-2	1/8	.97
32PLP-3	3/16	1.44
32PLP-4	1/4	1.16
32PLP-6	3/8	1.65
32PLP-8	1/2	2.17

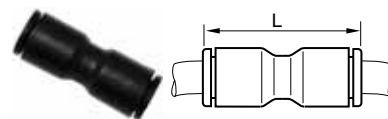

32PLP Converter

PART NO.	TUBE SIZE (IN)	TUBE SIZE (MM)	L
32PLP-6M-4	1/4	6	1.18
32PLP-10M-6	3/8	10	1.99
32PLP-12M-8	1/2	12	2.25

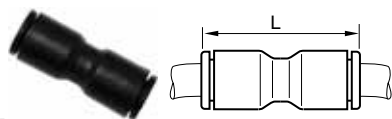

32PLP Unequal Union

PART NO.	1 TUBE SIZE (IN)	2 TUBE SIZE (IN)	L
32PLP-4M-2	5/32 (4M)	1/8	0.96
32PLP-4M-4	5/32 (4M)	1/4	1.16
32PLP-4-2	1/4	1/8	1.32
32PLP-8M-4	5/16 (8M)	1/4	1.44
32PLP-6-4	3/8	1/4	1.61
32PLP-6-8	3/8	1/2	2.17



365PLP Union Elbow

PART NO.	TUBE SIZE (IN)	L
365PLP-2	1/8	.71
365PLP-3	3/16	1.07
365PLP-4	1/4	.93
365PLP-6	3/8	1.33
365PLP-8	1/2	1.38

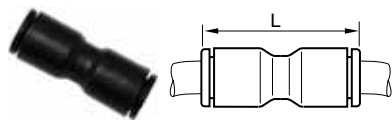

32PLP Union

PART NO.	TUBE SIZE (MM)	L
32PLP-3M	3	25.0
32PLP-4M	4	25.0
32PLP-6M	6	28.5
32PLP-8M	8	38.0
32PLP-10M	10	42.0
32PLP-12M	12	50.5
32PLP-14M	14	56.0
32PLP-16M	16	60.5



365PLP Unequal Union Elbow

PART NO.	1 TUBE SIZE (IN)	2 TUBE SIZE (IN)	L	H
365PLP-2-4	1/8	1/4	.93	.93
365PLP-4M-4	5/32 (4M)	1/4	.93	.93
365PLP-6-4	3/8	1/4	1.33	1.30
365PLP-6-8	3/8	1/2	1.81	1.81

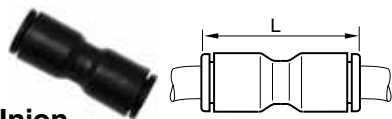

32PLP Unequal Union

PART NO.	1 TUBE SIZE (MM)	2 TUBE SIZE (MM)	L
32PLP-3M-4M	3	4	25.0
32PLP-6M-4M	6	4	28.0
32PLP-8M-4M	8	4	28.0
32PLP-8M-6M	8	6	38.0
32PLP-10M-6M	10	6	42.0
32PLP-10M-8M	10	8	42.0
32PLP-12M-10M	12	10	50.5
32PLP-12M-14M	12	14	56.0
32PLP-12M-8M	12	8	50.5
32PLP-16M-12M	16	12	61.0

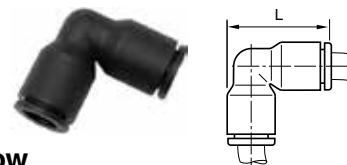

365PLP Union Elbow

PART NO.	TUBE SIZE (MM)	L
365PLP-4M	4	19.0
365PLP-6M	6	22.5
365PLP-8M	8	29.5
365PLP-10M	10	34.5
365PLP-12M	12	40.5
365PLP-14M	14	46.5
365PLP-16M	16	52.0



365PLP Unequal Union Elbow

PART NO.	1 TUBE SIZE (MM)	2 TUBE SIZE (MM)	L
365PLP-4M-6M	4	6	22.5
365PLP-6M-8M	6	8	29.5
365PLP-8M-10M	8	10	34.5
365PLP-10M-12M	10	12	40.5

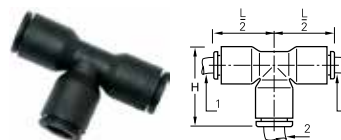

364PLP Unequal Union Tee

PART NO.	1 TUBE SIZE (MM)	2 TUBE SIZE (MM)	H	L/2
364PLP-4M-6M	4	6	22.5	17.5
364PLP-6M-4M	6	4	22.5	17.5
364PLP-6M-8M	6	8	29.5	23.0
364PLP-8M-6M	8	6	29.5	23.0
364PLP-8M-10M	8	10	34.5	26.5
364PLP-10M-12M	10	12	34.5	26.5
364PLP-10M-8M	10	8	40.5	31.0
364PLP-12M-10M	12	10	40.5	31.0
364PLP-14M-8M	14	8	46.0	35.5
364PLP-16M-12M	16	12	39.0	

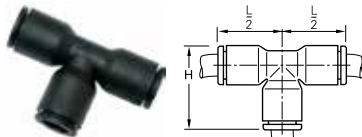

364PLP Union Tee

PART NO.	TUBE SIZE (IN)	L/2	H
364PLP-2	1/8	.57	.75
364PLP-3	3/16	.85	1.07
364PLP-4	1/4	.71	.92
364PLP-6	3/8	1.02	1.34
364PLP-8	1/2	1.38	1.81



362PLP Union Y

PART NO.	1 TUBE SIZE (IN)	2 TUBE SIZE (IN)	L	H	N
362PLP-2	1/8	1/8	1.12	.69	.35
362PLP-2-4	1/8	1/4	1.42	.87	.45
362PLP-4M-4	5/32 (4M)	1/4	1.42	.87	.45
362PLP-4	1/4	1/4	1.42	.87	.45
362PLP-4-6	1/4	3/8	2.02	1.30	.67
362PLP-6	3/8	3/8	2.09	1.30	.67

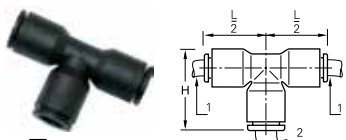

364PLP Unequal Union Tee

PART NO.	1 TUBE SIZE (IN)	2 TUBE SIZE (IN)	L/2	H
364PLP-2-4	1/8	1/4	.71	.93
364PLP-4M-4	5/32 (4M)	1/4	.71	.93
364PLP-4-2	1/4	1/8	.73	.93
364PLP-4-4M	1/4	5/32 (4M)	.73	.93
364PLP-4-6	1/4	3/8	.96	1.32
364PLP-6-4	3/8	1/4	1.00	1.28
364PLP-6-8	3/8	1/2	1.38	1.81
364PLP-8-4	1/2	1/4	1.38	1.81
364PLP-8-6	1/2	3/8	1.38	1.81

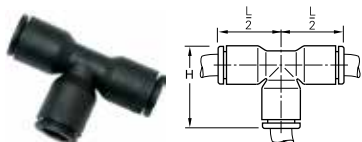

364PLP Union Tee

PART NO.	TUBE SIZE (MM)	H	L/2
364PLP-3M	3	19.0	14.5
364PLP-4M	4	19.0	14.5
364PLP-6M	6	23.5	18.0
364PLP-8M	8	29.5	23.0
364PLP-10M	10	34.5	26.5
364PLP-12M	12	40.5	31.0
364PLP-14M	14	46.0	35.5
364PLP-16M	16	52.0	39.0

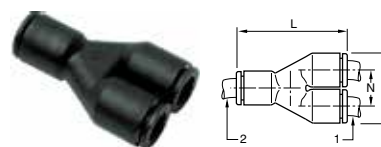

362PLP Union Y

PART NO.	1 TUBE SIZE (MM)	2 TUBE SIZE (M)	H	L	N
362PLP-4M	4	4	17.5	28.5	9.0
362PLP-6M	6	6	21.5	35.0	11.0
362PLP-8M	8	8	28.0	45.0	14.5
362PLP-10M	10	10	33.0	53.0	17.0
362PLP-4M-6M	4	6	17.5	33.0	9.0
362PLP-6M-8M	6	8	22.5	41.0	11.5
362PLP-8M-10M	8	10	28.0	47.0	14.5
362PLP-10M-12M	10	12	33.0	57.0	17.0

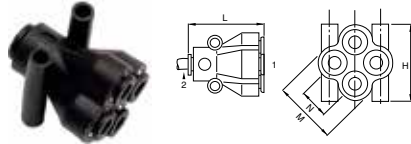

362PLPD Double Y Connector

PART NO.	1 TUBE SIZE (IN)	2 TUBE SIZE (IN)	H	L	M	N	MOUNTING HOLE DIA.
362PLPD-4M-4	5/32 (4M)	1/4	1.00	1.18	.83	.39	.15

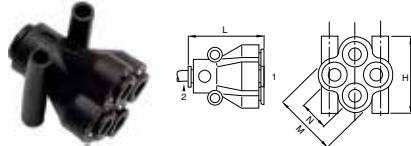

362PLPD Double Y Connector

PART NO.	1 TUBE SIZE (MM)	2 TUBE SIZE (MM)	H	L	M	N	MOUNTING HOLE DIA.
362PLPD-4M	4	4	25.5	30.5	21.0	10.0	3.7
362PLPD-6M	6	6	31.5	37.5	26.5	12.0	3.7
362PLPD-4M-6M	4	6	25.5	30.5	21.0	10.0	3.7
362PLPD-6M-8M	6	8	31.5	38.0	26.5	12.0	3.7



32PLPBH Bulkhead Union

PART NO.	TUBE SIZE (IN)	C HEX (MM)	K MAX	L1	L2	BULKHEAD THREAD	BULKHEAD HOLE DIA.
32PLPBH-2	1/8	13	.22	.37	.61	M10 X 1	12MM
32PLPBH-4	1/4	16	.35	.37	.81	M15 X 1	16MM
32PLPBH-6	3/8	22	.57	.51	1.18	M18 X 1.5	24MM
32PLPBH-8	1/2	29	.81	.67	1.61	M25 X 1.5	26MM



32PLPBH Bulkhead Union

PART NO.	TUBE SIZE (MM)	C HEX (MM)	K MAX	L1	L2	BULKHEAD THREAD	BULKHEAD HOLE DIA.
32PLPBH-4M	4	13	5.5	15.0	10.0	M12 X 1	12MM
32PLPBH-6M	6	15	8.5	18.0	10.5	M14 X 1	14MM
32PLPBH-8M	8	18	14.5	25.0	13.5	M16 X 1	16MM
32PLPBH-10M	10	22	14.5	27.5	15.5	M22 X 1.5	22MM
32PLPBH-12M	12	26	18.5	33.0	18.0	M24 X 1.5	24MM
32PLPBH-14M	14	29	20.5	37.5	20.5	M26 X 1.5	26MM

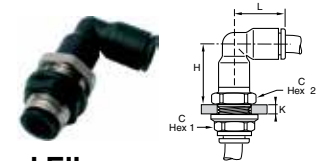

365PLPBH Equal Bulkhead Elbow

PART NO.	TUBE SIZE (IN)	C1 HEX	C2 HEX	K MAX	H	L	BULKHEAD THREAD	BULKHEAD HOLE DIA.
365PLPBH-2	1/8	13	13	.28	.71	.57	M10 X 1	10MM
365PLPBH-4M	5/32 (4M)		13	.26	.83	.67	M12 X 1	12MM
365PLPBH-4	1/4	18	17	.32	.87	.71	M15 X 1	15MM
365PLPBH-8M	5/16 (8M)		18	.31	1.22	.94	M16 X 1	16MM
365PLPBH-6	3/8	22	22	.33	1.08	1.00	M18 X 1.5	18MM
365PLPBH-8	1/2	29	27	.41	1.54	1.38	M25 X 1.5	25MM

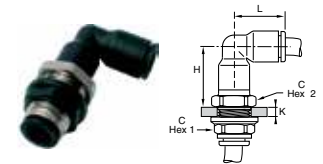

365PLPBH Equal Bulkhead Elbow

PART NO.	TUBE SIZE (MM)	C1 HEX	C2 HEX	K MAX	H	L	BULKHEAD THREAD	BULKHEAD HOLE DIA.
365PLPBH-4M	4	13	13	6.5	21.0	17.0	M12 X 1	12MM
365PLPBH-6M	6	15	15	7.0	24.5	19.5	M14 X 1	14MM
365PLPBH-8M	8	18	18	8.0	31.0	24.0	M16 X 1	16MM
365PLPBH-10M	10	22	22	8.5	36.0	28.0	M22 X 1.5	22MM
365PLPBH-12M	12	26	26	8.5	42.0	33.0	M24 X 1.5	24MM

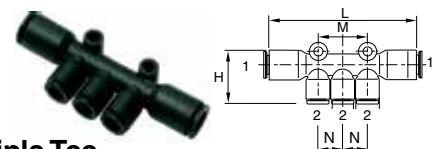

24PLP Multiple Tee

PART NO.	1 TUBE SIZE (IN)	2 TUBE SIZE (IN)	H	L	M	N	MOUNTING HOLE DIA.
24PLP-4-4M	1/4	5/32 (4M)	0.97	2.81	.90	.45	.17
24PLP-4-4	1/4	1/4	1.22	3.14	1.21	.61	.17
24PLP-6-4	3/8	1/4	1.34	3.21	1.22	.61	.17

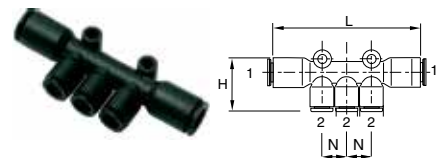

24PLP Multiple Tee

PART NO.	1 TUBE SIZE (MM)	2 TUBE SIZE (M)	H	L	N	MOUNTING HOLE DIA.
24PLP-6M-4M	6	4	24.5	74	11.5	4.2
24PLP-8M-4M	8	4	24.5	74	11.5	4.2
24PLP-8M-6M	8	6	24.5	74	11.5	4.2
24PLP-10M-6M	10	6	36.0	81	14.5	4.2
24PLP-10M-8M	10	8	36.0	81	14.5	4.2

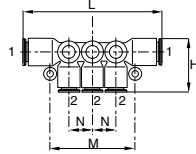

24PLPD Double Multiple Tee

PART NO.	1 TUBE SIZE (IN)	2 TUBE SIZE (IN)	H	L	M	N	MOUNTING HOLE DIA.
24PLPD-4-4M	1/4	5/32 (4M)	.73	2.84	1.69	.45	.17
24PLPD-4-4	1/4	1/4	.73	2.84	1.69	.45	.17
24PLPD-6-4	3/8	1/4	.91	3.31	2.05	.57	.17

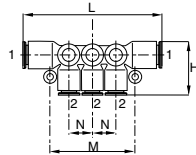

24PLPD Double Multiple Tee

PART NO.	1 TUBE SIZE (MM)	2 TUBE SIZE (MM)	H	L	M	N	MOUNTING HOLE DIA.
24PLPD-6M-4M	6	4	18.5	72.0	43.0	11.5	4.2
24PLPD-8M-4M	8	4	18.5	73.0	43.0	11.5	4.2
24PLPD-8M-6M	8	6	18.5	73.0	43.0	11.5	4.2
24PLPD-10M-6M	10	6	23.0	84.0	52.0	14.5	4.2
24PLPD-10M-8M	10	8	23.5	84.0	52.0	14.5	4.2

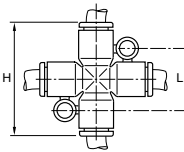

347PLP Equal Cross

PART NO.	TUBE SIZE (IN)	H	L	MOUNTING HOLE DIA.
347PLP-4	1/4	1.40	.79	.17

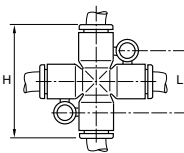

347PLP Equal Cross

PART NO.	TUBE SIZE (MM)	H	L	MOUNTING HOLE DIA.
347PLP-4M	4	36	20.0	4.2
347PLP-6M	6	36	20.0	4.2
347PLP-8M	8	46	22.5	4.2

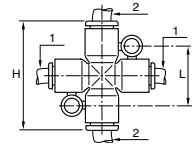

347PLP Unequal Cross

PART NO.	1 TUBE SIZE (MM)	2 TUBE SIZE (MM)	H	L	MOUNTING HOLE DIA.
347PLP-4M-6M	4	6	36	20.0	4.2
347PLP-6M-4M*	6	4	36	20.0	4.2
347PLP-6M-8M	6	8	46	22.5	4.2
347PLP-8M-6M*	8	6	46	22.5	4.2

*This model provides 3 outlines of "TUBE1" and 1 outlet of "TUBE 2".

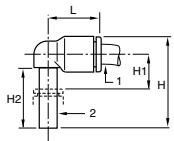

369PLPSP Plug-In Elbow

PART NO.	1 TUBE SIZE (IN)	2 TUBE SIZE (IN)	H	H1	H2	L
369PLPSP-2	1/8	1/8	.92	.31	.64	.57
369PLPSP-4M-4	5/32 (4M)	1/4	1.08	.30	.71	.71
369PLPSP-4	1/4	1/4	1.20	.43	.83	.73
369PLPSP-4-6	1/4	3/8	1.52	.35	.96	.98
369PLPSP-6	3/8	3/8	1.52	.35	.96	1.02
369PLPSP-8	1/2	1/2	2.00	.51	1.12	1.38

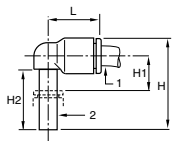

369PLPSP Plug-In Elbow

PART NO.	1 TUBE SIZE (MM)	2 TUBE SIZE (M)	H	H1	H2	L
369PLPSP-4M	4	4	23.0	6.0	15.5	14.0
369PLPSP-6M	6	6	26.5	7.0	17.0	16.0
369PLPSP-8M	8	8	33.5	8.0	21.5	23.0
369PLPSP-10M	10	10	39.0	9.5	24.5	23.5
369PLPSP-12M	12	12	44.5	10.0	27.5	31.0
369PLPSP-4M-6M	4	6	26.5	7.0	17.0	16.0
369PLPSP-6M-4M	6	4	24.5	7.0	15.5	16.0
369PLPSP-6M-8M	6	8	33.5	8.0	21.5	22.0
369PLPSP-8M-10M	8	10	39.0	8.5	24.5	26.5
369PLPSP-10M-12M	10	12	44.5	10.0	27.5	31.0

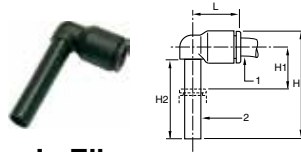

369PLPSPX Extended Plug-In Elbow

PART NO.	1 TUBE SIZE (IN)	2 TUBE SIZE (IN)	H	H1	H2	L
369PLPSPX-2	1/8	1/8	1.26	.65	.98	.57
369PLPSPX-4	1/4	1/4	1.56	.77	1.18	.71
369PLPSPX-6	3/8	3/8	2.19	1.02	1.63	1.02

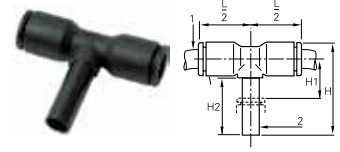

372PLPSP Plug-In Branch Tee

PART NO.	1 TUBE SIZE (IN)	2 TUBE SIZE (IN)	H	H1	H2	L/2
372PLPSP-2	1/8	1/8	.95	.26	.59	.57
372PLPSP-4	1/4	1/4	.98	.43	.77	.73
372PLPSP-6	3/8	3/8	1.61	.35	.96	.98
372PLPSP-8	1/2	1/2	2.01	.51	1.12	1.38



369PLPSPX Extended Plug-In Elbow

PART NO.	1 TUBE SIZE (MM)	2 TUBE SIZE (MM)	H	H1	H2	L
369PLPSPX-4M	4	4	32.5	15.5	25.0	14.0
369PLPSPX-6M	6	6	38.5	19.0	29.0	16.0
369PLPSPX-8M	8	8	49.0	23.5	37.0	23.0
369PLPSPX-10M	10	10	56.0	26.5	41.5	26.5
369PLPSPX-12M	12	12	62.5	28.0	45.5	31.0
369PLPSPX-4M-6M	4	6	38.5	19.0	29.0	16.0
369PLPSPX-6M-8M	6	8	49.0	23.5	37.0	23.0
369PLPSPX-8M-10M	8	10	56.0	26.5	41.5	26.5
369PLPSPX-10M-12M	10	12	62.5	28.0	45.5	31.0

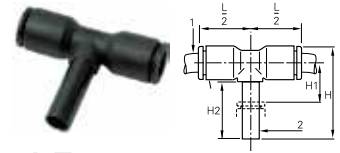

372PLPSP Plug-In Branch Tee

PART NO.	1 TUBE SIZE (MM)	2 TUBE SIZE (MM)	H	H1	H2	L/2
372PLPSP-4M	4	4	23.0	6.0	15.5	14.5
372PLPSP-6M	6	6	26.5	7.0	17.0	16.0
372PLPSP-8M	8	8	33.5	8.0	21.5	23.0
372PLPSP-10M	10	10	39.0	9.5	24.5	26.5
372PLPSP-12M	12	12	44.5	10.0	27.5	31.0
372PLPSP-4M-6M	4	6	26.5	7.0	17.0	16.0
372PLPSP-6M-8M	6	8	33.5	8.0	21.5	23.0
372PLPSP-8M-10M	8	10	39.0	9.5	24.5	26.5
372PLPSP-10M-12M	10	12	44.5	10.0	27.5	31.0

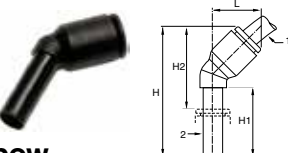

379PLPSP 45° Plug-In Elbow

PART NO.	1 TUBE SIZE (IN)	2 TUBE SIZE (IN)	H	H1	H2	L
379PLPSP-2	1/8	1/8	1.14	.59	.69	.47
379PLPSP-4	1/4	1/4	1.44	.71	.87	.57
379PLPSP-6	3/8	3/8	2.00	.96	1.16	.91

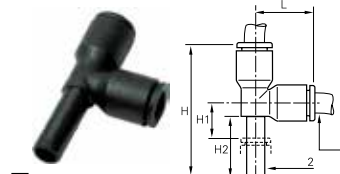

371PLPSP Plug-In Run Tee

PART NO.	1 TUBE SIZE (IN)	2 TUBE SIZE (IN)	H	H1	H2	L
371PLPSP-4	1/4	1/4	1.69	.43	.83	.73
371PLPSP-6	3/8	3/8	2.23	.33	.96	1.00
371PLPSP-8	1/2	1/2	2.86	.51	1.12	1.38

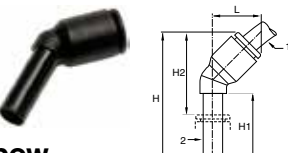

379PLPSP 45° Plug-In Elbow

PART NO.	1 TUBE SIZE (MM)	2 TUBE SIZE (MM)	H	H1	H2	L
379PLPSP-4M	4	4	33.5	19.0	21.0	13.0
379PLPSP-6M	6	6	39.0	21.0	25.0	14.5
379PLPSP-8M	8	8	44.0	21.5	25.5	19.5
379PLPSP-10M	10	10	53.0	27.0	32.5	23.0
379PLPSP-12M	12	12	58.5	27.5	34.0	26.5

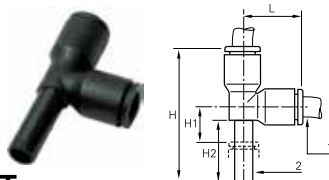

371PLPSP Plug-In Run Tee

PART NO.	1 TUBE SIZE (MM)	2 TUBE SIZE (MM)	H	H1	H2	L
371PLPSP-4M	4	4	33.0	6.0	15.5	14.5
371PLPSP-6M	6	6	38.5	7.0	17.0	17.5
371PLPSP-8M	8	8	49.0	8.0	21.5	23.0
371PLPSP-10M	10	10	57.0	10.5	24.5	26.5
371PLPSP-12M	12	12	65.5	10.5	27.5	31.0
371PLPSP-4M-6M	4	6	10.5	7.0	17.0	17.5
371PLPSP-6M-8M	6	8	13.5	8.0	21.5	23.0
371PLPSP-8M-10M	8	10	16.0	10.5	24.5	26.5
371PLPSP-10M-12M	10	12	19.0	10.5	27.5	31.0

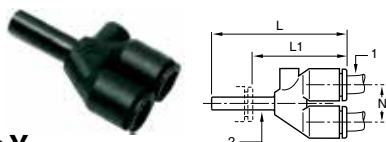

362PLPSP Plug-In Y

PART NO.	1 TUBE SIZE (IN)	2 TUBE SIZE (IN)	L	L1	N
362PLPSP-2	1/8	1/8	1.36	1.00	.35
362PLPSP-4	1/4	1/4	1.60	1.02	.45
362PLPSP-6	3/8	3/8	2.23	1.42	.67

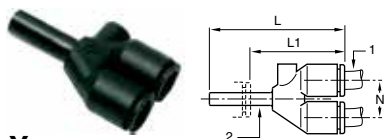

362PLPSP Plug-In Y

PART NO.	1 TUBE SIZE (MM)	2 TUBE SIZE (M)	L	L1	N
362PLPSP-4M	4	4	34.0	21.5	9.0
362PLPSP-6M	6	6	39.5	25.5	11.0
362PLPSP-8M	8	8	50.5	32.0	14.5
362PLPSP-10M	10	10	57.5	36.0	17.0
362PLPSP-12M	12	12	66.0	41.0	20.0
362PLPSP-4M-6M	4	6	35.5	21.5	9.0
362PLPSP-6M-8M	6	8	44.0	25.5	11.0
362PLPSP-8M-10M	8	10	53.5	32.0	14.5
362PLPSP10M-12M	10	12	60.0	35.0	17.0

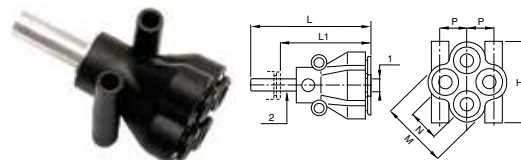

362PLPDSP Plug-In Multiple Y

PART NO.	1 TUBE SIZE (MM)	2 TUBE SIZE (M)	H	L	L1	M	N
362PLPDSP-4M-6M	4	6	25.5	45.0	31.0	21.0	10.0
362PLPDSP-4M-8M	4	8	25.5	49.5	31.0	21.0	10.0
362PLPDSP-6M-8M	6	8	31.5	59.5	41.0	26.5	12.0

*Aluminum tail piece

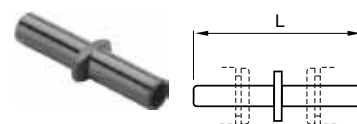

63PLP Double Male Union

PART NO.	TUBE SIZE (IN)	L
63PLP-4	1/4	1.52
63PLP-6	3/8	2.03
63PLP-8*	1/2	2.13

*Nickel-plated brass

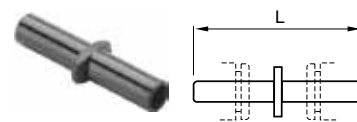

63PLP Double Male Union

PART NO.	TUBE SIZE (MM)	L
63PLP-4M	4	34 1/2
63PLP-6M	6	38 1/2
63PLP-8M	8	41
63PLP-10M	10	51 1/2
63PLP-12M	12	60
63PLP-14M	14	69 1/2

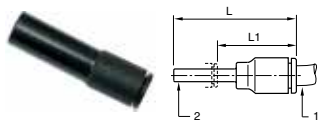

67PLP Tube Reducer

PART NO.	1 TUBE SIZE (IN)	2 TUBE SIZE (IN)	L	L1
67PLP-2-4M	1/8	5/32 (4M)	1.79	1.32
67PLP-2-3	1/8	3/16	1.79	1.14
67PLP-2-4	1/8	1/4	1.79	1.22
67PLP-4M-3	5/32 (4M)	3/16	1.48	.83
67PLP-4M-4	5/32 (4M)	1/4	1.48	.91
67PLP-4M-6	5/32 (4M)	3/8	1.61	.81
67PLP-3-8M	3/16	5/16 (8M)	1.79	1.06
67PLP-3-4	3/16	1/4	1.79	1.22
67PLP-4-8M	1/4	5/16 (8M)	1.61	.89
67PLP-4-6	1/4	3/8	1.61	.81
67PLP-4-8	1/4	1/2	1.97	.98
67PLP-8M-6	5/16 (8M)	3/8	1.93	1.12
67PLP-8M-8	5/16 (8M)	1/2	2.01	1.02
67PLP-6-8	3/8	1/2	2.01	1.04

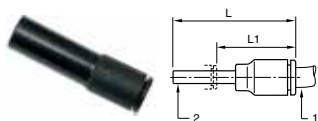

67PLP Tube Reducer

PART NO.	1 TUBE SIZE (MM)	2 TUBE SIZE (MM)	L	L1
67PLP-4M-6M	4	6	37.5	23.5
67PLP-4M-8M	4	8	37.5	19.0
67PLP-6M-8M	6	8	36.0	20.5
67PLP-4M-10M	4	10	44.0	22.5
67PLP-6M-10M	6	10	38.0	17.5
67PLP-8M-10M	8	10	49.0	28.5
67PLP-10M-12M	10	12	56.5	33.5
67PLP-6M-12M	6	12	46.0	23.0
67PLP-8M-12M	8	12	49.0	24.5
67PLP-10M-14M	10	14	58.5	33.5
67PLP-12M-14M	12	14	58.5	33.5
67PLP-6M-14M	6	14	48.0	23.0
67PLP-8M-14M	8	14	48.0	23.0

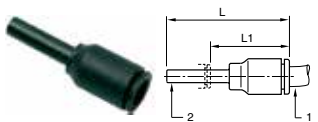

32PLPSP Tube Expander

PART NO.	1 TUBE SIZE (IN)	2 TUBE SIZE (IN)	L	L1
32PLPSP-4-2	1/4	1/8	1.61	1.16
32PLPSP-4-6M	1/4	6M	1.75	1.02
32PLPSP-4-4M	1/4	5/32 (4M)	1.61	1.14
32PLPSP-4-3	1/4	3/16	1.61	1.00
32PLPSP-6-4	3/8	1/4	1.58	1.00



32PLPSP Tube Expander

PART NO.	1 TUBE SIZE (MM)	2 TUBE SIZE (MM)	L	L1
32PLPSP-6M-4M	6	4	35.0	23.0
32PLPSP-8M-6M	8	6	45.0	31.5
32PLPSP-10M-8M	10	8	42.5	21.0
32PLPSP-12M-10M	12	10	49.0	24.5



32PLPSP Tube Converter

PART NO.	1 TUBE SIZE (IN)	2 TUBE SIZE (MM)	L	L1
32PLPSP-4M-2	4M	1/8	1.61	1.16
32PLPSP-8M-4	8M	1/4	1.58	1.00



639PLP Plug Inch

PART NO.	TUBE SIZE	L
639PLP-2	1/8	1.30
639PLP-3	3/16	1.36
639PLP-4	1/4	1.44
639PLP-6	3/8	1.67
639PLP-8	1/2	1.91

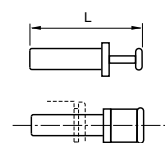

639PLP Plug Metric

PART NO.	TUBE SIZE	L
639PLP-3M	3	25
639PLP-4M	4	30
639PLP-6M	6	33
639PLP-8M	8	33
639PLP-10M	10	42
639PLP-12M	12	45
639PLP-14M	14	49
639PLP-16M	16	57

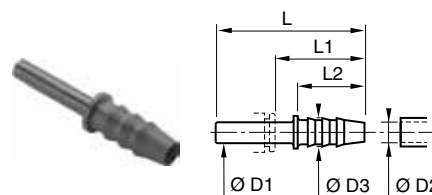

322PLPSP Barbed Connector

PART NO.	OD 1	OD 2	OD 3	L	L1	L2
322PLPSP-4M-2	5/32 (4M)	.120	.20	1.46	.98	.67
322PLPSP-4M-5M	5/32 (4M)	.200	.28	1.46	.98	.67
322PLPSP-4-3*	1/4	3/16		1.65	1.00	
322PLPSP-8M-4	5/16 (8M)	.250	.34	1.55	.83	.67
322PLPSP-8M-5	5/16 (8M)	.320	.39	1.75	1.02	.87
322PLPSP-6-5	3/8	.320	.39	1.97	1.16	.87
322PLPSP-8-6*	1/2	.375	.57	2.28	1.34	.87

*Nickel-plated brass. Dimensions for OD2 are I.D. of the tube.

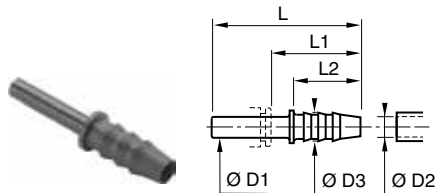

322PLPSP Barbed Connector

PART NO.	OD 1	OD 2	OD 3	L	L1	L2
322PLPSP-4M-3M	4	3.2	5.0	37.0	25.0	17.0
322PLPSP-4M-5M	4	5.0	7.0	37.0	25.0	17.0
322PLPSP-6M-5M	6	5.0	7.0	39.0	25.0	17.0
322PLPSP-8M-6M	8	6.3	8.5	39.5	21.0	17.0
322PLPSP-8M-8M	8	8.0	10.0	44.5	26.0	22.0
322PLPSP-10M-6M	10	6.3	8.0	45.0	24.5	17.0
322PLPSP-10M-8M	10	8.0	10.0	50.0	29.5	22.0
322PLPSP-12M-8M	12	8.0	10.0	50.0	26.0	22.0
322PLPSP-12M-10M	12	10.0	12.0	48.5	25.5	22.5
322PLPSP-12M-12M	12	12.5	14.5	57.0	34.0	22.5
322PLPSP-14M-12M	14	12.5	14.5	59.5	34.5	22.5
322PLPSP-14M-14M*	14	14.0	16.0	59.5	34.5	22.5

*Nickel-plated brass. Dimensions for OD2 are I.D. of the tube.

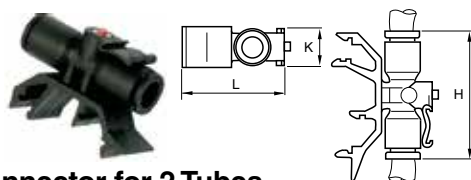

32PLPRC Connector for 2 Tubes

PART NO.	TUBE SIZE (IN)	H	K	L
32PLPRC-4	1/4	1.44	.47	1.18

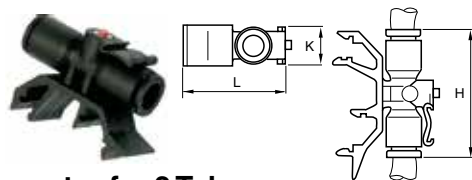

32PLPRC Connector for 2 Tubes

PART NO.	TUBE SIZE (MM)	H	K	L
32PLPRC-4M	4	36.5	11.0	39.5
32PLPRC-6M	6	36.5	11.0	39.5
32PLPRC-8M	8	46.0	13.0	44.5

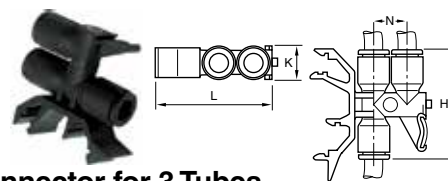

32PLPDRC Connector for 3 Tubes

PART NO.	TUBE SIZE (MM)	H	K	L	N
32PLPDRC-4M	4	36.5	11.0	39.5	
32PLPDRC-6M	6	36.5	11.0	39.5	
32PLPDRC-8M	8	46.0	13.0	14.5	



Clip Strips for Tubing and Fittings

PART NO.	D TUBE	LF3000 TO BE CLIPPED	H MM	K MM	N MM	NO. PER STRIP
CLIP 04 00	5/32, 4MM	-	9	13.5	10.5	8
CLIP 06 00	1/4, 3/16, 6MM	-	10.5	13	10.5	8
CLIP 08 00	5/16, 8MM	5/32, 4MM	12.5	10.5	12	7
CLIP 10 00	3/8, 10MM	1/4, 6MM	14	12	15	6
CLIP 12 00	1/2, 12MM		16.5	14	16.5	5
CLIP 14 00	14MM	5/16, 8MM	18	16	20.5	4

Clip strips come complete with screws of .375 inches in length.



3151 End Caps

PART NO.	D IN	G MM	H MM
3151 53 00	1/8	.33	.55
3151 04 00	5/32	.33	.55
3151 56 00	1/4	.41	.64
3151 08 00	5/16	.53	.86
3151 60 00	3/8	.53	.86

3151 End Caps

PART NO.	D MM	G MM	H MM
3151 04 00	4	8.5	14.7
3151 06 00	6	10.5	16.9
3151 08 00	8	13.5	21.9
3151 10 00	10	16	22.2
3151 12 00	12	19	27.7

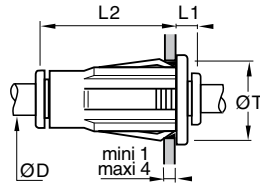

Minimum distance between fittings.
Diameter of fixing hole.

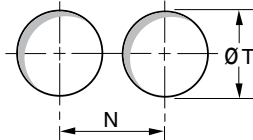

32PLPBHP Plug-in Bulkhead Union

PART NO.	TUBE SIZE (IN)	L1	L2	ØT
32PLPBHP-4M	5/32 (4M)	.26	1.080	.62
32PLPBHP-4	1/4	.26	1.240	.75
32PLPBHP-8M	5/16 (8M)	.30	1.280	.87
32PLPBHP-6	3/8	.30	1.630	1.12
32PLPBHP-8	1/2	.30	1.710	1.25

Fixing Hole

D		5/32	1/4	5/16	3/8	1/2
T	inches	5/8"	3/4"	7/8"	1 1/8"	1 1/4"
	mm	15.87	19.05	22.22	28.57	31.75
N	in	.89	1.00	1.08	1.34	1.50

Tolerance T: +0.3 -0.1

Installation

1. Mark out the fixing hole
2. Make hole in panel
3. Simply push the fitting into place
4. To complete the installation
5. To identify circuits simply remove the black release button and replace with colored one

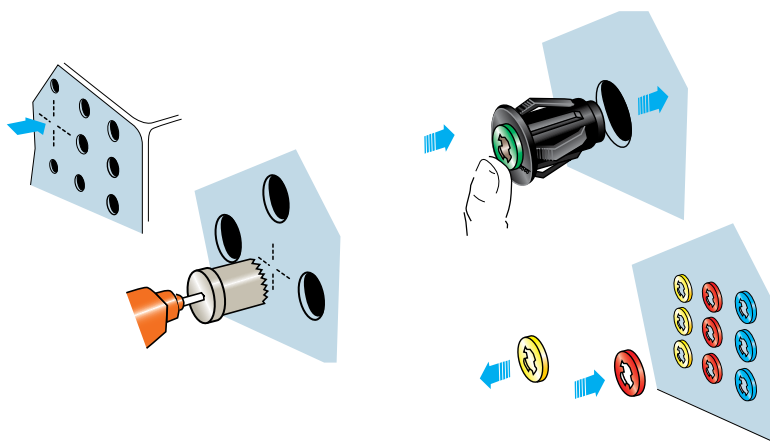

3110 - 3330 Caps Manual Release Button - Inch

TUBE O.D.	WHITE PART NO.	BLACK PART NO.	GREEN PART NO.	RED PART NO.	BLUE PART NO.	YELLOW PART NO.
1/8	3110 53 00	-	3110 53 02	3110 53 03	3110 53 04	3110 53 05
5/32	3110 04 00	3330 04 01	3110 04 02	3110 04 03	3110 04 04	3110 04 05
3/16	3330 55 00	3330 55 01	3330 55 02	3330 55 03	3330 55 04	3330 55 05
1/4	3110 56 00	3330 56 01	3110 56 02	3110 56 03	3110 56 04	3110 56 05
5/16	3110 08 00	-	3110 08 02	3110 08 03	3110 08 04	3110 08 05
3/8	3110 60 00	-	3110 60 02	3110 60 03	3110 60 04	3110 60 05
1/2	3110 62 00	3330 62 01	3110 62 02	3110 62 03	3110 62 04	3110 62 05

3110 - 3330 Caps Manual Release Button - Metric

TUBE MM	WHITE PART NO.	BLACK PART NO.	GREEN PART NO.	RED PART NO.	BLUE PART NO.	YELLOW PART NO.
4	3110 04 00	3330 04 01	3110 04 02	3110 04 03	3110 04 04	3110 04 05
6	3110 06 00	3330 06 01	3110 06 02	3110 06 03	3110 06 04	3110 06 05
8	3110 08 00	-	3110 08 02	3110 08 03	3110 08 04	3110 08 05
10	3110 10 00	-	3110 10 02	3110 10 03	3110 10 04	3110 10 05
12	3110 12 00	-	3110 12 02	3110 12 03	3110 12 04	3110 12 05
14	3110 14 00	-	3110 14 02	3110 14 03	3110 14 04	3110 14 05

In all sizes of the LF3000 fittings, except 3/16, the push button is an integral part of the design which makes it non-removable, and comes standard in black. For identification of the circuits, colored caps (p/n 3110) fit over the black push button.

On the 3/16 sizes, the buttons are removable and can be replaced with a button of another color (p/n 3330).

Six colors are available which allow color coding of the fitting, in association with tubes of the same color.



Prestolok PLM Metal Push-to-Connect Fittings

To meet your technical and environment requirements, Parker's Prestlok PLM fittings offers the robustness, reliability and resistance to industrial fluids for the most demanding environments.

Product Features:

- High phosphorous, FDA-compliant, chemical resistant, nickel-plated collet and body
- FKM seal
- Chemical, corrosion, and abrasion resistance
- NPT, BSPT, BSPP, and metric threads

Markets:

- Industrial
- Chemical
- Life Science
- Automation
- Food Processing

Applications:

- Food fluids
- harsh Detergents
- Cleaning In Cold/ Hot Water
- Steam
- Oils

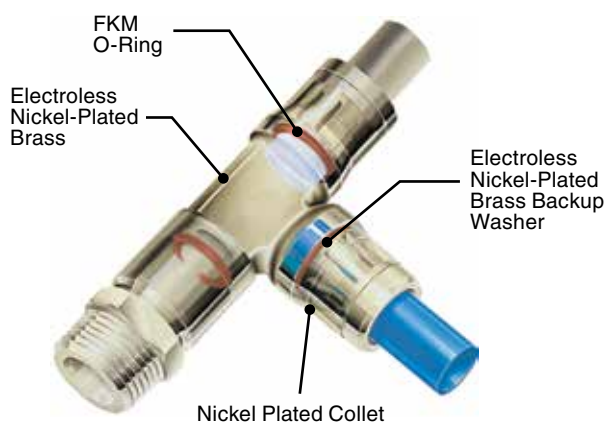

Specifications:

Pressure Range 7 to 290 psi





































Temperature Range -4° to +302°F

Note: Max. pressure and temperature rangedepend on the type of tubing used.



Compatible Tubing:

- Polyethylene
- Polyurethane 95 Durometer Shore A
- FEP
- Nylon

Tube to Male NPT	68PLM Male Connector  p. A38	169PLM Male Elbow  p. A39	171PLM Male Run Tee  p. A40	172PLM Male Branch Tee  p. A41	Tube to Tube	62PLM Union  p. A42
	165PLM Union Elbow  p. A43	164PLM Union Tee  p. A43	Bulkhead Union  p. A42	Male Standpipes  p. A39		68PLMSP Male Standpipe to BSPT  p. A39
Metric Tube to Male BSPT	68PLM Male Connector  p. A38	169PLM Male Elbow  p. A39	169PLMX Extended Male Elbow  p. A40	171PLM Male Run Tee  p. A41	172PLM Male Branch Tee  p. A41	
	Metric Tube to Male BSPP  p. A38	169PLM Male Elbow  p. A40	169PLMX Extended Male Elbow  p. A40	171PLM Male Run Tee  p. A41	172PLM Male Branch Tee  p. A42	
Metric Tube to Female BSPP	66PLM Female Connector  p. A38	Metric Tube to Metric Tube  p. A42	62PLM Union  p. A43	165PLM Union Elbow  p. A43	164PLM Union Tee  p. A43	
	Metric Bulkhead Unions  p. A42	66PLMBH Female Bulkhead  p. A42	165PLMBH Bulkhead Union  p. A43	Metric Plug-in  p. A43	67PLM Tube Reducer  p. A44	
62PLMSP Tube Converter  p. A44	122PLMSP Barbed Connector  p. A44	Metric Banjo Fitting  p. A44	Metric Auxiliary Components  p. A44	639PLM Plug  p. A44	PLMC Cartridge  p. A44	
63PLM Double Male Union  p. A44						

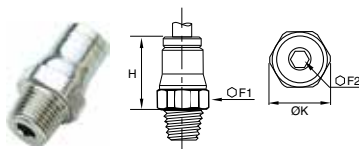

68PLM Male Connector Inch Tube to NPT/UNF

PART NO.	TUBE SIZE IN	NPT/UNF	F1 MM	F2 MM	H IN	K IN
68PLM-5/32-0	5/32	10-32	10	2.5	.61	.43
68PLM-5/32-2	5/32	1/8	11	3.0	.59	.47
68PLM-5/32-4	5/32	1/4	14	3.0	.59	.59
68PLM-4-0	1/4	10-32	13	2.5	.75	.55
68PLM-4-2	1/4	1/8	13	4.0	.67	.55
68PLM-4-4	1/4	1/4	14	4.0	.67	.59
68PLM-4-6	1/4	3/8	18	5.0	.67	.77
68PLM-6-2	3/8	1/8	18	4.0	.97	.77
68PLM-6-4	3/8	1/4	18	7.0	.95	.77
68PLM-6-6	3/8	3/8	18	8.0	.91	.77
68PLM-6-8	3/8	1/2	22	8.0	.95	.94
68PLM-8-6	1/2	3/8	22	9.0	.95	.94
68PLM-8-8	1/2	1/2	22	10.0	.95	.94

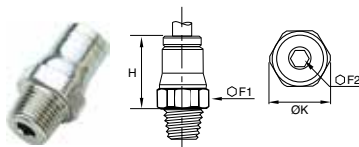

68PLM Male Connector Metric Tube to BSPT

PART NO.	TUBE SIZE MM	BSPT	F1 MM	F2 MM	H MM	K MM
68PLM-4M-2R	4	1/8	10	3	15.00	11.00
68PLM-4M-4R	4	1/4	14	3	15.00	15.00
68PLM-6M-2R	6	1/8	13	4	17.00	14.00
68PLM-6M-4R	6	1/4	14	4	17.00	15.00
68PLM-8M-2R	8	1/8	15	5	19.00	16.00
68PLM-8M-4R	8	1/4	15	6	18.00	16.00
68PLM-8M-6R	8	3/8	17	6	18.50	18.50
68PLM-10M-4R	10	1/4	18	7	23.00	19.50
68PLM-10M-6R	10	3/8	18	8	22.50	19.50
68PLM-10M-8R	10	1/2	22	8	22.50	24.00
68PLM-12M-4R	12	1/4	20	7	25.50	22.00
68PLM-12M-6R	12	3/8	20	9	24.00	22.00
68PLM-12M-8R	12	1/2	22	10	23.00	24.00
68PLM-14M-6R	14	3/8	22	9	27.00	24.00
68PLM-14M-8R	14	1/2	24	11	26.00	26.00

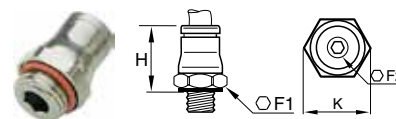

68PLM Male Connector Tube to UNF, BSPP or Metric

PART NO.	TUBE SIZE MM	BSPP/METRIC	F1 MM	F2 MM	H MM	K MM
68PLM-4M-M5	4	M5X0.8	10	2.50	15.50	11.00
68PLM-4M-M6	4	M6X1	13	3.00	14.50	14.00
68PLM-4M-2G	4	1/8	10	3.00	16.00	11.00
68PLM-4M-4G	4	1/4	16	3.00	14.50	17.50
68PLM-4M-M8	4	M8X1	11	3.00	14.50	12.00
68PLM-6M-M5	6	M5X0.8	13	2.50	19.00	14.00
68PLM-6M-2G	6	1/8	13	4.00	17.50	14.00
68PLM-6M-M10	6	M10X1	13	4.00	17.50	14.00
68PLM-6M-4G	6	1/4	16	4.00	17.00	17.50
68PLM-8M-2G	8	1/8	15	5.00	20.00	16.00
68PLM-8M-4G	8	1/4	16	6.00	18.00	17.50
68PLM-8M-6G	8	3/8	20	6.00	19.00	22.00
68PLM-10M-4G	10	1/4	18	7.00	25.00	19.50
68PLM-10M-6G	10	3/8	20	8.00	22.50	22.00
68PLM-10M-8G	10	1/2	24	8.00	22.50	26.00
68PLM-12M-4G	12	1/4	20	7.00	27.00	22.00
68PLM-12M-6G	12	3/8	20	9.00	26.00	22.00
68PLM-12M-8G	12	1/2	24	10.00	23.50	26.00
68PLM-14M-6G	14	3/8	22	9.00	28.00	24.00
68PLM-14M-8G	14	1/2	24	11.00	26.50	26.00

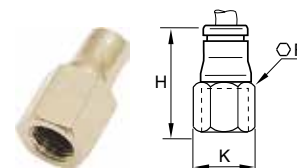

66PLM Female Connector Metric Tube to BSPP or M5

PART NO.	TUBE SIZE MM	BSPP/M5	F MM	H MM	K MM
66PLM-4M-M5	4	M5X0.8	10	22.00	11.00
66PLM-4M-2G	4	1/8	14	25.00	15.00
66PLM-4M-4G	4	1/4	17	29.00	18.50
66PLM-6M-2G	6	1/8	14	27.50	15.00
66PLM-6M-4G	6	1/4	17	31.50	18.50
66PLM-8M-2G	8	1/8	15	28.50	16.00
66PLM-8M-4G	8	1/4	17	32.50	18.50
66PLM-10M-6G	10	3/8	22	38.00	24.00
66PLM-12M-6G	12	3/8	22	39.00	24.00
66PLM-12M-8G	12	1/2	24	43.50	26.00

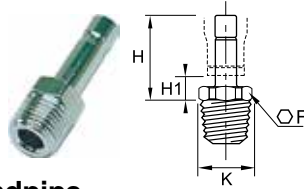

68PLMSP Male Stud Standpipe Metric Tube to BSPT

PART NO.	TUBE SIZE MM	BSPT	F MM	H MM	H1 MM	K MM
68PLMSP-4M-2R	4	1/8	10	21.00	7.00	11.00
68PLMSP-6M-2R	6	1/8	10	23.50	6.50	11.00
68PLMSP-6M-4R	6	1/4	10	23.50	6.50	15.00
68PLMSP-8M-2R	8	1/8	10	24.00	6.50	11.00
68PLMSP-8M-4R	8	1/4	14	24.00	6.50	15.00
68PLMSP-10M-4R	10	1/4	14	22.00	6.50	15.00
68PLMSP-10M-6R	10	3/8	17	30.00	7.50	18.50
68PLMSP-12M-6R	12	3/8	17	31.00	7.50	18.50
68PLMSP-12M-8R	12	1/2	22	38.00	7.50	24.00
68PLMSP-14M-8R	14	1/2	22	33.00	8.00	24.00

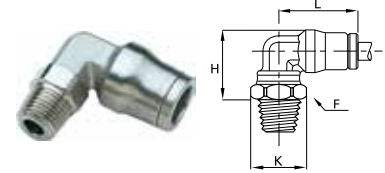

169PLM Male Elbow Inch Tube to NPT, UNF

PART NO.	TUBE SIZE IN	NPT/UNF	F MM	H IN	K IN	L IN
169PLM-5/32-0	5/32	10-32	10	0.71	0.43	.71
169PLM-5/32-2	5/32	1/8	11	.59	.47	.71
169PLM-5/32-4	5/32	1/4	14	.67	.60	.71
169PLM-4-2	1/4	1/8	11	.69	.47	.87
169PLM-4-4	1/4	1/4	14	.75	.60	.87
169PLM-4-6	1/4	3/8	18	.75	.77	.87
169PLM-6-4	3/8	1/4	15	.93	.63	1.14
169PLM-6-6	3/8	3/8	18	1.02	.77	1.14
169PLM-6-8	3/8	1/2	22	1.06	.94	1.14
169PLM-8-6	1/2	3/8	18	1.14	.77	1.22
169PLM-8-8	1/2	1/2	22	1.14	.94	1.22

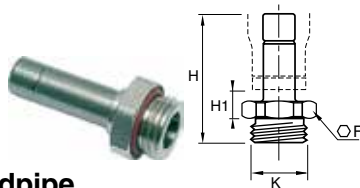

68PLMSP Male Standpipe Metric Tube to BSPP or M5

PART NO.	TUBE SIZE MM	BSPP/M5	F MM	H MM	H1 MM	K MM
68PLMSP-4M-M5	4	M5X0.8	13	25.50	7.00	14.00
68PLMSP-4M-2G	4	1/8	16	26.50	7.00	17.50
68PLMSP-4M-4G	4	1/4	8	25.00	7.50	8.70
68PLMSP-6M-2G	6	1/8	13	28.00	6.50	14.00
68PLMSP-6M-4G	6	1/4	16	29.00	6.50	17.50
68PLMSP-8M-2G	8	1/8	13	28.50	6.50	14.00
68PLMSP-8M-4G	8	1/4	16	29.50	6.50	17.50
68PLMSP-8M-6G	8	3/8	20	30.50	7.50	22.00
68PLMSP-10M-4G	10	1/4	16	34.50	6.50	17.50
68PLMSP-10M-6G	10	3/8	20	35.50	7.50	22.00
68PLMSP-10M-8G	10	1/2	24	37.00	7.50	26.00
68PLMSP-12M-6G	12	3/8	20	36.50	7.50	22.00
68PLMSP-12M-8G	12	1/2	24	38.00	7.50	26.00
68PLMSP-14M-8G	14	1/2	24	40.00	8.00	26.00

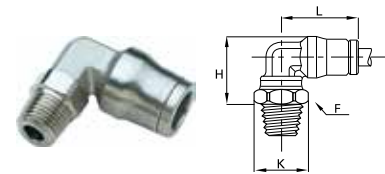

169PLM Male Elbow Metric Tube to BSPT

PART NO.	TUBE SIZE MM	BSPT	F MM	H MM	K MM	L MM
169PLM-4M-2R	4	1/8	11	15.00	12.00	18.00
169PLM-4M-4R	4	1/4	14	17.00	15.00	18.00
169PLM-6M-2R	6	1/8	11	17.50	12.00	21.50
169PLM-6M-4R	6	1/4	14	19.00	15.00	21.50
169PLM-8M-2R	8	1/8	11	19.50	12.00	23.50
169PLM-8M-4R	8	1/4	14	21.00	15.00	23.50
169PLM-8M-6R	8	3/8	17	21.00	18.50	23.50
169PLM-10M-4R	10	1/4	15	23.50	16.00	29.00
169PLM-10M-6R	10	3/8	17	25.50	18.50	29.00
169PLM-12M-4R	12	1/4	15	26.00	16.00	31.00
169PLM-12M-6R	12	3/8	17	28.50	18.50	31.00
169PLM-12M-8R	12	1/2	21	28.50	23.00	31.00
169PLM-14M-6R	14	3/8	19	29.00	21.00	34.00
169PLM-14M-8R	14	1/2	24	30.00	26.00	34.00

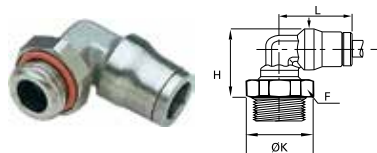

169PLM Male Elbow Tube to BSPP, Metric

PART NO.	TUBE SIZE MM	BSPP/METRIC	F MM	H MM	K MM	L MM
169PLM-4M-M5	4	M5X0.8	10	18.00	11.00	18.00
169PLM-4M-2G	4	1/8	13	17.00	14.00	18.00
169PLM-4M-M6	4	M6X1	10	18.00	11.00	18.00
169PLM-4M-4G	4	1/4	16	17.50	17.50	18.00
169PLM-4M-M8	4	M8X1	11	18.00	12.00	18.00
169PLM-6M-2G	6	1/8	13	19.00	14.00	21.50
169PLM-6M-M10	6	M10X1	13	19.00	14.00	21.50
169PLM-6M-4G	6	1/4	16	19.50	17.50	21.50
169PLM-8M-2G	8	1/8	13	20.50	14.00	23.50
169PLM-8M-4G	8	1/4	16	21.50	17.50	23.50
169PLM-8M-6G	8	3/8	20	21.50	22.00	23.50
169PLM-10M-4G	10	1/4	16	27.00	17.50	29.00
169PLM-10M-6G	10	3/8	20	25.50	22.00	29.00
169PLM-12M-4G	12	1/4	16	29.50	17.50	31.00
169PLM-12M-6G	12	3/8	20	28.50	22.00	31.00
169PLM-12M-8G	12	1/2	24	28.50	26.00	31.00
169PLM-14M-6G	14	3/8	20	29.00	22.00	34.00
169PLM-14M-8G	14	1/2	24	29.50	26.00	34.00

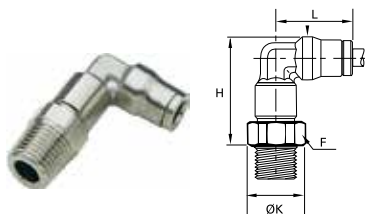

169PLMX Extended Male Elbow Metric Tube to BSPT

PART NO.	TUBE SIZE MM	BSPT	F MM	H MM	K MM	L MM
169PLMX-4M-2R	4	1/8	10	24.50	11.00	18.00
169PLMX-6M-2R	6	1/8	13	29.50	14.00	21.50
169PLMX-6M-4R	6	1/4	14	30.50	15.00	21.50
169PLMX-8M-2R	8	1/8	14	32.50	15.00	23.50
169PLMX-8M-4R	8	1/4	14	34.00	15.00	23.50
169PLMX-10M-4R	10	1/4	18	39.00	19.50	29.00

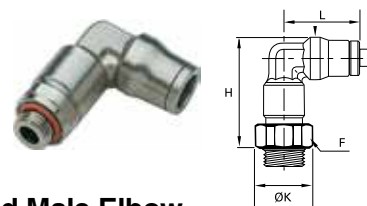

169PLMX Extended Male Elbow Metric Tube to BSPP or M5

PART NO.	TUBE SIZE MM	BSPP/M5	F MM	H MM	K MM	L MM
169PLMX-4M-M5	4	M5X0.8	10	27.50	11.00	18.00
169PLMX-4M-2G	4	1/8	13	25.50	14.00	18.00
169PLMX-6M-2G	6	1/8	13	31.00	14.00	18.00
169PLMX-6M-4G	6	1/4	16	30.50	17.50	21.50
169PLMX-8M-2G	8	1/8	14	33.50	15.00	23.50
169PLMX-8M-4G	8	1/4	16	34.00	17.50	23.50
169PLMX-10M-4G	10	1/4	18	42.00	19.50	29.00
169PLMX-10M-6G	10	3/8	20	41.00	22.00	29.00
169PLMX-12M-4G	12	1/4	20	47.00	22.00	31.00
169PLMX-12M-6G	12	3/8	20	46.00	22.00	31.00
169PLMX-14M-8G	14	1/2	24	49.00	26.00	34.00

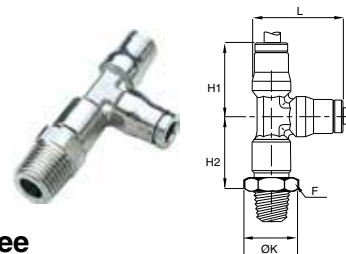

171PLM Male Run Tee Inch Tube to Tube to NPT, UNF

PART NO.	TUBE SIZE IN	NPT/UNF	F MM	H1 IN	H2 IN	K IN	L IN
171PLM-5/32-0	5/32	10-32	10			.47	.91
171PLM-5/32-2	5/32	1/8	11	.71	.77	.47	.91
171PLM-5/32-4	5/32	1/4	14	.71	.85	.59	.91
171PLM-4-2	1/4	1/8	13	.87	.93	.55	1.12
171PLM-4-4	1/4	1/4	14	.87	.97	.59	1.12
171PLM-6-4	3/8	1/4	18	1.14	1.20	.77	1.48
171PLM-6-6	3/8	3/8	18	1.14	1.28	.77	1.48
171PLM-6-8	3/8	1/2	22	1.14	1.28	.94	1.48
171PLM-8-6	1/2	3/8	22	1.22	1.46	.94	1.61
171PLM-8-8	1/2	1/2	22	1.22	1.50	.94	1.61

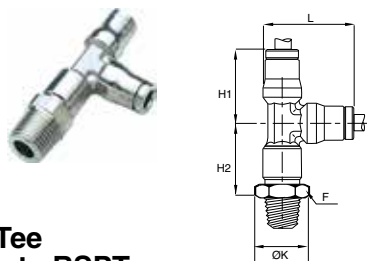

**171PLM Male Run Tee
Metric Tube To Tube to BSPT**

PART NO.	TUBE SIZE MM	BSPT	F MM	H1 MM	H2 MM	K MM	L MM
171PLM-4M-2R	4	1/8	10	18.00	19.50	11.00	23.00
171PLM-6M-2R	6	1/8	13	21.50	23.50	14.00	28.00
171PLM-6M-4R	6	1/4	14	21.50	24.50	15.00	28.00
171PLM-8M-2R	8	1/8	14	23.50	25.00	15.00	31.00
171PLM-8M-4R	8	1/4	14	23.50	26.50	15.00	31.00
171PLM-10M-4R	10	1/4	18	29.00	30.50	19.50	37.50
171PLM-10M-6R	10	3/8	18	29.00	32.50	19.50	37.50
171PLM-12M-6R	12	3/8	21	31.00	36.50	23.00	40.50
171PLM-14M-8R	14	1/2	22	34.00	40.00	24.00	45.00

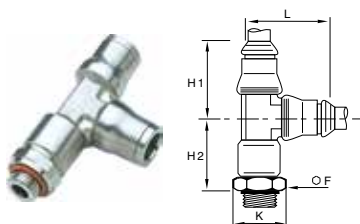

**171PLM Male Run Tee
Tube To Tube to BSPP or M5**

PART NO.	TUBE SIZE MM	BSPP/ M5	F MM	H1 MM	H2 MM	K MM	L MM
171PLM-4M-M5	4	M5X0.8	10	18.00	22.50	11.00	23.00
171PLM-4M-2G	4	1/8	13	18.00	20.50	14.00	23.00
171PLM-6M-2G	6	1/8	13	21.50	25.00	14.00	28.00
171PLM-6M-4G	6	1/4	16	21.50	24.50	17.50	28.00
171PLM-8M-2G	8	1/8	14	23.50	26.50	15.00	31.00
171PLM-8M-4G	8	1/4	16	23.50	26.50	17.50	31.00
171PLM-10M-4G	10	1/4	18	29.00	33.00	19.50	37.50
171PLM-12M-6G	12	3/8	21	31.00	36.50	23.00	40.50
171PLM-14M-8G	14	1/2	24	34.00	38.50	26.00	45.00

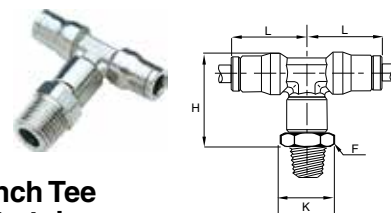

**172PLM Male Branch Tee
Inch Tube to NPT to tube**

PART NO.	TUBE SIZE IN	NPT/UNF	F MM	H IN	K IN	L IN
172PLM-5/32-0	5/32	10-32	10.00	1.00	.47	.71
172PLM-5/32-2	5/32	1/8	11	.87	.47	.71
172PLM-5/32-4	5/32	1/4	14	1.04	.59	.71
172PLM-4-2	1/4	1/8	13	1.18	.55	.87
172PLM-4-4	1/4	1/4	14	1.22	.59	.87
172PLM-4-6	1/4	3/8	18	1.22	.77	.87
172PLM-6-4	3/8	1/4	18	1.54	.77	1.14
172PLM-6-6	3/8	3/8	18	1.61	.77	1.14
172PLM-6-8	3/8	1/2	22	1.61	.94	1.14
172PLM-8-6	1/2	3/8	22	1.85	.94	1.22
172PLM-8-8	1/2	1/2	22	1.89	.94	1.22

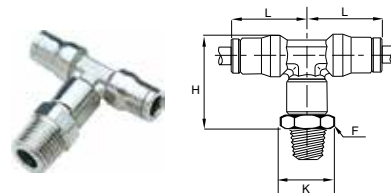

**172PLM Male Branch Tee
Metric Tube to BSPT**

PART NO.	TUBE SIZE MM	BSPT	F MM	H MM	K MM	L MM
172PLM-4M-2R	4	1/8	10	24.50	11.00	18.00
172PLM-6M-2R	6	1/8	13	29.50	14.00	21.50
172PLM-6M-4R	6	1/4	14	30.50	15.00	21.50
172PLM-8M-2R	8	1/8	14	32.50	15.00	23.50
172PLM-8M-4R	8	1/4	14	34.00	15.00	23.50
172PLM-10M-4R	10	1/4	18	39.00	19.50	29.00
172PLM-10M-6R	10	3/8	18	41.00	19.50	29.00
172PLM-12M-6R	12	3/8	21	46.50	23.00	31.00
172PLM-14M-8R	14	1/2	22	50.50	24.00	34.00

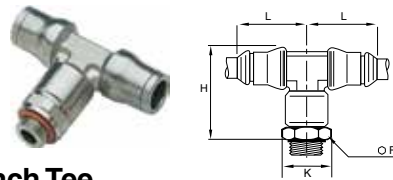

172PLM Male Branch Tee
Tube to BSPP or M5

PART NO.	TUBE SIZE MM	BSPP/M5	F MM	H MM	K MM	L MM
172PLM-4M-M5	4	M5X0.8	10	27.50	11.00	18.00
172PLM-4M-2G	4	1/8	13	25.50	14.00	18.00
172PLM-6M-2G	6	1/8	13	31.00	14.00	21.50
172PLM-6M-4G	6	1/4	16	30.50	17.50	21.50
172PLM-8M-2G	8	1/8	14	33.50	15.00	23.50
172PLM-8M-4G	8	1/4	16	34.00	17.50	23.50
172PLM-10M-4G	10	1/4	18	42.00	19.50	29.00
172PLM-12M-6G	12	3/8	21	46.00	23.00	31.00
172PLM-14M-8G	14	1/2	24	49.00	26.00	34.00

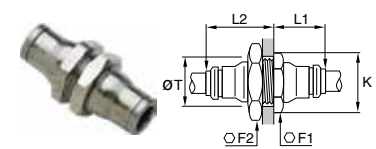

62PLMBH Bulkhead Connector
Inch Tube to Tube

PART NO.	TUBE SIZE IN	F1 MM	F2 MM	K IN	L1 IN	L2 IN	T IN
62PLMBH-4	1/4	16	17	.69	.67	.89	.59
62PLMBH-6	3/8	22	27	.95	.87	1.10	.85
62PLMBH-8	1/2	24	24	1.16	.89	1.14	1.04

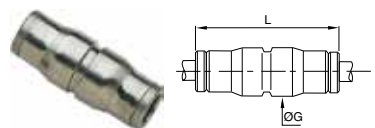

62PLM Straight Union
Inch Tube to Tube

PART NO.	TUBE SIZE IN	G IN	L IN
62PLM-4	1/4	.49	1.44
62PLM-6	3/8	.67	1.87
62PLM-8	1/2	.79	1.89

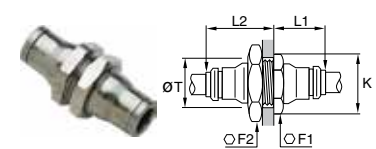

62PLMBH Bulkhead Connector
Metric Tube to Tube

PART NO.	TUBE SIZE MM	F1 MM	F2 MM	K MM	L1 MM	L2 MM	T MM
62PLMBH-4M (5/32)	4	13	14	14.00	14.00	20.00	12.50
62PLMBH-6M	6	16	17	17.50	17.00	22.00	15.00
62PLMBH-8M (5/16)	8	18	19	19.50	18.50	23.50	17.00
62PLMBH-10M	10	22	27	24.00	21.50	26.50	21.00
62PLMBH-12M	12	24	24	26.00	23.00	27.00	23.00
62PLMBH-14M	14	27	27	29.50	25.50	29.50	25.00

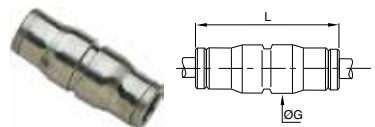

62PLM Straight Union
Metric Tube to Tube

PART NO.	TUBE SIZE MM	G MM	L MM
62PLM-4M (5/32)	4	10.00	30.50
62PLM-6M	6	12.00	36.50
62PLM-8M (5/16)	8	15.00	37.50
62PLM-10M	10	17.50	47.50
62PLM-12M	12	19.50	50.00
62PLM-14M	14	21.50	52.50

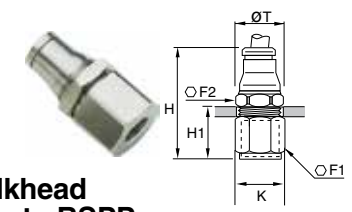

66PLMBH Female Bulkhead Connector
Metric Tube to BSPP

PART NO.	TUBE SIZE MM	BSPP	F1 MM	F2 MM	H MM	H1 MM	K MM	T MM
66PLMBH-4M-2G	4	1/8	14	14	30.50	11.00	15.00	13
66PLMBH-6M-2G	6	1/8	17	17	32.50	11.00	18.50	15
66PLMBH-6M-4G	6	1/4	17	17	37.00	15.00	18.50	15
66PLMBH-8M-2G	8	1/8	19	19	34.00	10.50	21.00	17
66PLMBH-8M-4G	8	1/4	19	19	38.00	14.50	21.00	17
66PLMBH-10M-6G	10	3/8	22	27	42.50	16.00	24.00	21
66PLMBH-12M-6G	12	3/8	24	24	43.00	16.00	26.00	23
66PLMBH-12M-8G	12	1/2	27	24	48.50	21.50	29.50	23

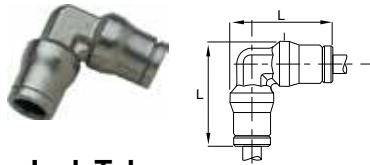

165PLM Union Elbow Inch Tube

PART NO.	TUBE SIZE IN	L IN
165PLM-4	1/4	1.12
165PLM-6	3/8	1.48
165PLM-8	1/2	1.61

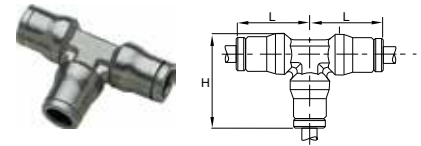

164PLM Union Tee Inch Tube

PART NO.	TUBE SIZE IN	H IN	L IN
164PLM-4	1/4	1.12	.87
164PLM-6	3/8	1.48	1.14
164PLM-8	1/2	1.61	1.22

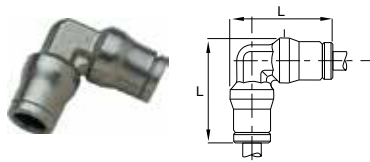

165PLM Union Elbow Metric Tube

PART NO.	TUBE SIZE MM	L MM
165PLM-4M (5/32)	4	23.00
165PLM-6M	6	28.00
165PLM-8M (5/16)	8	31.00
165PLM-10M	10	37.50
165PLM-12M	12	40.50
165PLM-14M	14	45.00

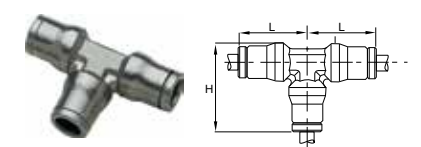

164PLM Union Tee Metric Tube

PART NO.	TUBE SIZE MM	H MM	L MM
164PLM-4M (5/32)	4	23.00	18.00
164PLM-6M	6	28.00	21.50
164PLM-8M (5/16)	8	31.00	23.50
164PLM-10M	10	37.50	29.00
164PLM-12M	12	40.50	31.00
164PLM-14M	14	45.00	34.00

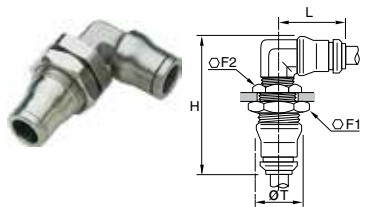

165PLMBH Bulkhead Elbow Metric Tube

PART NO.	TUBE SIZE MM	F1 MM	F2 MM	H MM	L MM	T MM
165PLMBH-4M	4	13	14	35.00	18.00	12.50
165PLMBH-6M	6	16	17	40.50	21.50	15.00
165PLMBH-8M	8	18	19	44.00	23.50	17.00
165PLMBH-10M	10	22	27	51.00	29.00	21.00
165PLMBH-12M	12	24	24	55.00	31.00	23.00
165PLMBH-14M	14	27	27	59.00	34.00	25.00

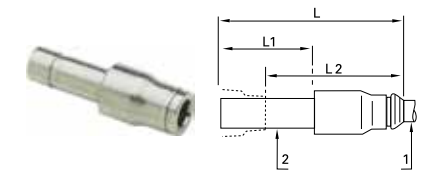

67PLM Plug-In Reducer Metric

PART NO.	TUBE 1 SIZE MM	TUBE 2 SIZE MM	L MM	L1 MM	L2 MM
67PLM-4M-6M	4	6	34.50	19.00	17.50
67PLM-4M-8M	4	8	35.50	20.00	18.00
67PLM-6M-8M	6	8	37.00	20.00	19.50
67PLM-6M-10M	6	10	43.50	25.00	21.00
67PLM-8M-10M	8	10	44.00	25.00	21.50
67PLM-8M-12M	8	12	45.00	26.00	21.50
67PLM-10M-12M	10	12	50.00	26.00	26.50
67PLM-12M-14M	12	14	53.00	28.00	28.50

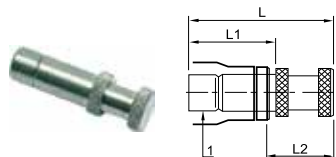

639PLM Plug Metric

PART NO.	TUBE 1 SIZE MM	L MM	L1 MM	L2 MM
639PLM-4M	4	25.50	17.00	11.50
639PLM-6M	6	30.50	19.50	13.50
639PLM-8M	8	33.00	20.00	16.00
639PLM-10M	10	40.00	25.00	18.00
639PLM-12M	12	43.00	26.00	20.00
639PLM-14M	14	47.00	28.00	22.50

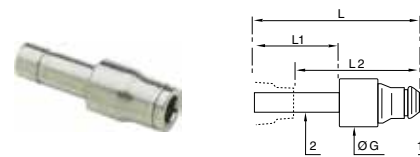

62PLMSP Plug-In Expander Metric

PART NO.	TUBE 1 SIZE MM	TUBE 2 SIZE MM	G MM	L MM	L1 MM	L2 MM
62PLMSP-4-6	6	4	17	42	22	28

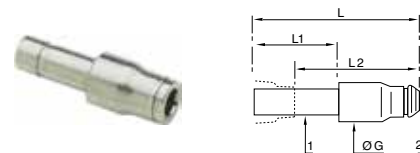

62PLMSP Plug-In Metric/Inch Adapter

PART NO.	TUBE 1 SIZE MM	TUBE 2 SIZE IN	G MM	L MM	L1 MM	L2 MM
62PLMSP-6M-4	6	1/4	12.50	38.00	19.00	20.50
62PLMSP-10M-6	10	3/8	17.00	49.50	25.00	27.00
62PLMSP-12M-8	12	1/2	20.00	51.00	26.00	27.50

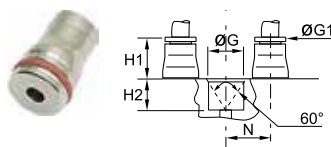

PLMC Cartridge

PART NO.	TUBE SIZE MM	G + .1 - 0	H1 MM	H2 MM	N MM
PLMC-4M	4	10.00	9.00	8.50	11.00
PLMC-6M	6	12.00	11.00	8.50	13.50
PLMC-8M	8	15.00	12.50	8.50	16.00
PLMC-10M	10	17.50	14.50	10.50	20.00
PLMC-12M	12	19.50	15.00	10.50	22.50
PLMC-14M	14	21.50	16.50	12.00	25.00

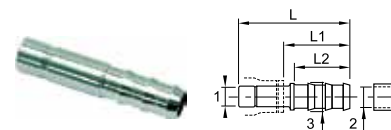

122PLMSP Plug-In Barbed Connector Metric

PART NO.	TUBE 1 SIZE MM	TUBE 2 SIZE MM	TUBE 3 SIZE MM	L MM	L1 MM	L2 MM
122PLMSP-4M-3M	4	3.20	5.00	40.50	27.00	22.50
122PLMSP-4M-5M	4	5.00	7.00	40.50	27.00	22.50
122PLMSP-6M-5M	6	5.00	7.00	43.00	27.00	22.50
122PLMSP-8M-6M	8	6.30	8.30	42.00	25.00	22.50
122PLMSP-8M-8M	8	8.00	10.00	44.00	27.00	22.50
122PLMSP-10M-6M	10	6.30	10.00	47.50	25.50	22.50
122PLMSP-10M-8M	10	8.00	8.30	47.50	25.50	22.50
122PLMSP-12M-8M	12	8.00	10.00	48.50	25.50	22.50
122PLMSP-12M10M	12	10.00	12.00	48.50	25.50	22.50
122PLMSP-12M12M	12	12.50	14.50	57.00	34.00	29.50
122PLMSP-14M12M	14	12.50	14.50	57.50	33.00	29.50
122PLMSP-14M14M	14	14.00	16.00	59.50	35.00	29.50

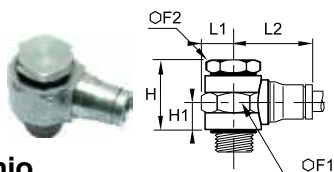

169PLMBJ Single Banjo Metric Tube to BSPP or M5

PART NO.	TUBE SIZE MM	BSPP/M5	F1 MM	F2 MM	H MM	H1 MM	L1 MM	L2 MM
169PLMBJ-4M-M5	4	M5X0.8	10	8	14.50	6.50	6.00	18.50
169PLMBJ-4M-2G	4	G1/8	17	14	23.00	9.50	10.00	20.50
169PLMBJ-6M-M5	6	M5X0.8	10	8	15.00	7.00	6.00	22.50
169PLMBJ-6M-2G	6	G1/8	17	14	23.00	9.50	10.00	23.50
169PLMBJ-6M-4G	6	G1/4	22	17	22.00	9.00	13.00	25.50
169PLMBJ-8M-2G	8	G1/8	17	14	23.00	9.50	10.00	26.00
169PLMBJ-8M-4G	8	G1/4	22	17	22.00	9.00	13.00	27.50
169PLMBJ-10M-6G	10	G3/8	22	22	33.00	14.00	13.00	32.00



63PLM Double Male Union Metric

PART NO.	TUBE SIZE MM	L MM	L1 MM
63PLM-4M	4	31.00	14.00
63PLM-6M	6	36.50	17.00
63PLM-8M	8	37.50	17.50
63PLM-10M	10	47.50	22.50
63PLM-12M	12	49.50	23.50
63PLM-14M	14	53.00	25.00

Prestolok PLP - Order Today, SHIP TODAY at www.ConnectorSpecialists.com



Prestolok PLS Stainless Steel Push-to-Connect Fittings

Parker's Prestolok PLS fittings are ideal for conveying corrosive fluids in aggressive environments. Prestolok PLS fittings provide corrosion resistance and a hygienic external design.

Product Features:

- Stainless steel 303L collet
- Stainless steel 316L body
- FKM seal
- Stainless steel 316L backup washer
- Chemical, corrosion, and abrasion resistance
- Hygienic design reduces retention zones for easy cleaning
- NPT, BSPT, BSPP, and metric threads

Markets:

- Petrochemical
- Life Science
- Pulp and Paper
- Food Processing
- Wash Down

Applications:

- Food Fluids
- Chemicals
- Cleaning Agents

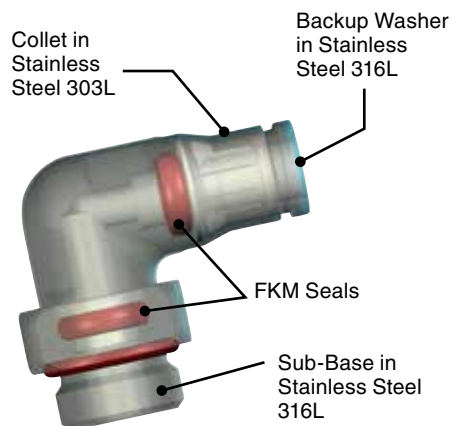

Specifications:

Pressure Range Up to 290 psi depending on type of tubing





Temperature Range -4° to +302°F

Vacuum Capability 28" Hg

Compatible Tubing:

- Semi-rigid nylon
- Polyethylene
- Polyurethane 95 Durometer Shore A
- Stainless Steel (grooved)
- Copper (grooved)



Tube to Male NPT	68PLS Male Connector  p. A48	169PLS Male Elbow  p. A50	171PLS Male Run Tee  p. A52	172PLS Male Branch Tee  p. A53	Tube to Tube  p. A53
	165PLS Union Elbow  p. A54	164PLS Union Tee  p. A54	Bulkhead Union  p. A54	Standpipe to NPT  p. A49	
Metric Tube to Male BSPT	68PLS Male Connector  p. A48	169PLS Male Elbow  p. A50			169PLSX Extended Male Elbow  p. A51
	Metric Tube to Male BSPP	68PLS Male Connector  p. A48	169PLS Male Elbow  p. A50	169PLSX Extended Male Elbow  p. A51	171PLS Male Run Tee  p. A52
Metric Tube to Male NPT		68PLS Male Connector  p. A48	169PLS Male Elbow  p. A50	169PLSX Extended Male Elbow  p. A51	171PLS Male Run Tee  p. A52
	Metric Tube to Metric Tube	62PLS Union  p. A53	165PLS Union Elbow  p. A54	164PLS Union Tee  p. A54	Metric Bulkhead Union  p. A54
Metric Standpipes		68PLSSP Male Standpipe to NPT  p. A49	68PLSSP Male Standpipe to BSPT  p. A49	68PLSSP Male Standpipe to BSPP  p. A49	
	Metric Auxiliary Components	639PLS Plug  p. A55	PLSC Cartridge  p. A55		

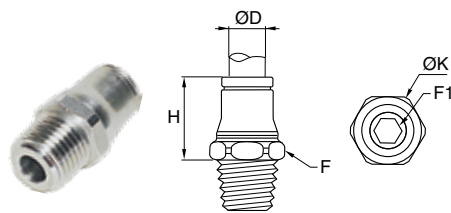

68PLS Male Connector - Inch Tube to NPT, UNF

PART NO.	TUBE SIZE IN	NPT / UNF	F MM	F1 MM	H IN	K IN
68PLS-5/32-0	5/32	10-32	10	2.5	.59	.43
68PLS-3-2	3/16	1/8	10	3	.61	.43
68PLS-3-4	3/16	1/4	14	3	.61	.59
68PLS-4-2	1/4	1/8	13	4	.75	.55
68PLS-4-4	1/4	1/4	14	4	.69	.59
68PLS-6-4	3/8	1/4	19	6	.98	.83
68PLS-6-6	3/8	3/8	19	7	.94	.83
68PLS-8-4	1/2	1/4	22	7	1.02	.94
68PLS-8-6	1/2	3/8	22	8	.98	.94
68PLS-8-8	1/2	1/2	22	10	.98	.94

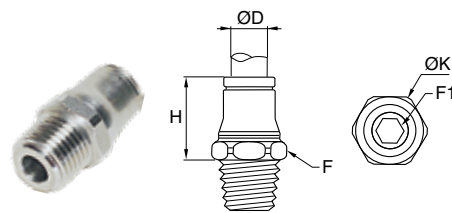

68PLS Male Connector - Metric Tube to BSPT

PART NO.	TUBE SIZE MM	BSPT	F MM	F1 MM	H MM	K MM
68PLS-4M-2R	4	1/8	10	3	14.50	11.00
68PLS-4M-4R	4	1/4	14	3	14.50	15.00
68PLS-6M-2R	6	1/8	13	4	18.00	14.00
68PLS-6M-4R	6	1/4	14	4	16.50	15.00
68PLS-8M-2R	8	1/8	15	5	20.50	16.50
68PLS-8M-4R	8	1/4	15	5	19.00	16.50
68PLS-8M-6R	8	3/8	17	6	19.00	18.50
68PLS-10M-4R	10	1/4	19	6	24.00	21.00
68PLS-10M-6R	10	3/8	19	7	22.50	21.00
68PLS-12M-4R	12	1/4	22	7	25.00	24.00
68PLS-12M-6R	12	3/8	22	8	24.00	24.00
68PLS-12M-8R	12	1/2	22	10	23.00	24.00

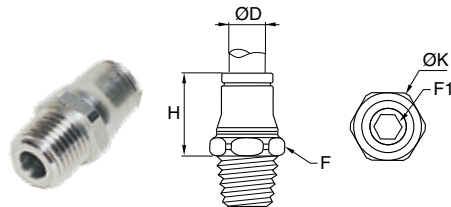

68PLS Male Connector - Metric Tube to NPT

PART NO.	TUBE SIZE MM	NPT	F MM	F1 MM	H MM	K MM
68PLS-4M-2 (5/32 - 2)	4	1/8	11	3	14.50	12.00
68PLS-6M-2	6	1/8	13	4	18.00	14.00
68PLS-6M-4	6	1/4	14	4	16.50	15.00
68PLS-8M-2 (5/16 - 2)	8	1/8	15	5	19.00	16.50
68PLS-8M-4 (5/16 - 4)	8	1/4	15	6	18.00	16.50
68PLS-10M-4	10	1/4	19	6	24.00	21.00
68PLS-10M-6	10	3/8	19	7	22.50	21.00
68PLS-12M-4	12	1/4	22	7	25.00	24.00
68PLS-12M-6	12	3/8	22	8	24.00	24.00
68PLS-12M-8	12	1/2	22	10	23.00	24.00

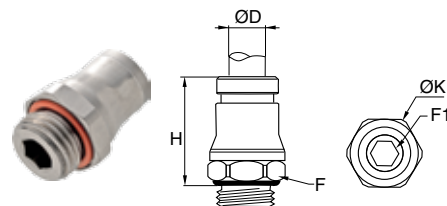

68PLS Male Connector - Metric Tube to BSPP, M5

PART NO.	TUBE SIZE MM	BSPP / M5	F MM	F1 MM	H MM	K MM
68PLS-4M-M5	4	M5X0.8	10	2.5	16.00	11.00
68PLS-4M-2G	4	1/8	13	3	15.00	14.00
68PLS-6M-M5	6	M5X0.8	13	2.5	20.50	14.00
68PLS-6M-2G	6	1/8	13	4	18.00	14.00
68PLS-6M-4G	6	1/4	17	4	18.00	18.50
68PLS-8M-2G	8	1/8	15	5	19.00	16.50
68PLS-8M-4G	8	1/4	17	5	20.50	18.50
68PLS-8M-6G	8	3/8	21	6	20.00	23.00
68PLS-10M-4G	10	1/4	18	7	25.00	19.50
68PLS-10M-6G	10	3/8	21	7	25.00	23.00
68PLS-12M-4G	12	1/4	21	7	27.00	23.00
68PLS-12M-6G	12	3/8	21	9	26.50	23.00

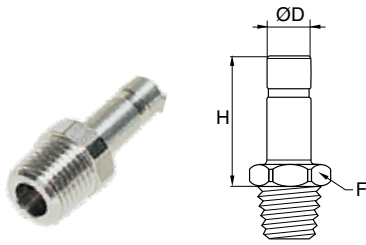

68PLSSP Male Standpipe - Inch Tube to NPT

PART NO.	TUBE SIZE IN	NPT	F IN	H IN
68PLSSP-3-2	3/16	1/8	0.39	0.98
68PLSSP-4-2	1/4	1/8	0.39	1.02
68PLSSP-4-4	1/4	1/4	0.55	1.06
68PLSSP-6-4	3/8	1/4	0.75	1.26
68PLSSP-6-6	3/8	3/8	0.75	1.26
68PLSSP-8-4	1/2	1/4	0.75	1.42
68PLSSP-8-6	1/2	3/8	0.75	1.46
68PLSSP-8-8	1/2	1/2	0.87	1.46

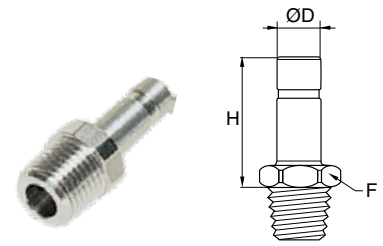

68PLSSP Male Standpipe - Metric Tube to BSPT

PART NO.	TUBE SIZE MM	BSPT	F MM	H MM
68PLSSP-4M-2R	4	1/8	10	21
68PLSSP-6M-2R	6	1/8	10	23
68PLSSP-6M-4R	6	1/4	14	24
68PLSSP-8M-2R	8	1/8	10	24
68PLSSP-8M-4R	8	1/4	14	25
68PLSSP-10M-4R	10	1/4	14	30
68PLSSP-10M-6R	10	3/8	17	30
68PLSSP-12M-4R	12	1/4	14	31
68PLSSP-12M-6R	12	3/8	17	31
68PLSSP-12M-8R	12	1/2	22	32

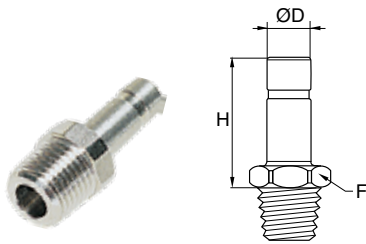

68PLSSP Male Standpipe - Metric Tube to NPT

PART NO.	TUBE SIZE MM	NPT	F MM	H MM
68PLSSP-4M-2 (5/32 - 2)	4	1/8	11	21
68PLSSP-6M-2	6	1/8	11	23
68PLSSP-6M-4	6	1/4	14	24
68PLSSP-8M-2 (5/16 - 2)	8	1/8	14	24
68PLSSP-8M-4 (5/16 - 4)	8	1/4	14	25
68PLSSP-10M-4	10	1/4	14	30
68PLSSP-10M-6	10	3/8	17	30
68PLSSP-12M-4	12	1/4	14	31
68PLSSP-12M-6	12	3/8	17	31
68PLSSP-12M-8	12	1/2	22	32

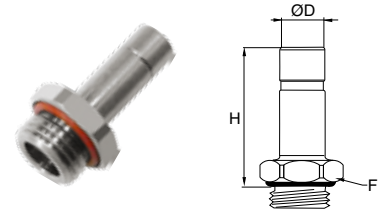

68PLSSP Male Standpipe - Metric Tube to BSPP, M5

PART NO.	TUBE SIZE MM	BSPP / M5	F MM	H MM
68PLSSP-4M-M5	4	M5X0.8	7	23.50
68PLSSP-4M-2G	4	1/8	13	22.00
68PLSSP-6M-2G	6	1/8	13	24.00
68PLSSP-6M-4G	6	1/4	17	24.00
68PLSSP-8M-2G	8	1/8	13	25.00
68PLSSP-8M-4G	8	1/4	17	27.00
68PLSSP-8M-6G	8	3/8	21	27.00
68PLSSP-10M-4G	10	1/4	17	32.00
68PLSSP-10M-6G	10	3/8	21	27.00
68PLSSP-12M-4G	12	1/4	17	33.00
68PLSSP-12M-6G	12	3/8	21	33.00

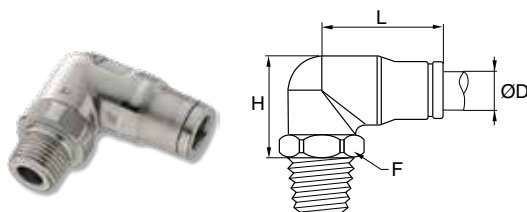

169PLS Male Elbow - Inch Tube to NPT, UNF

PART NO.	TUBE SIZE IN	NPT / UNF	F MM	H IN	L IN
169PLS-5/32-0	5/32	10-32	10	.98	.77
169PLS-3-2	3/16	1/8	10	.81	.77
169PLS-3-4	3/16	1/4	14	.81	.77
169PLS-4-2	1/4	1/8	13	.85	.91
169PLS-4-4	1/4	1/4	14	.85	.91
169PLS-6-4	3/8	1/4	17	1.12	1.20
169PLS-6-6	3/8	3/8	19	1.12	1.20
169PLS-8-4	1/2	1/4	22	1.34	1.30
169PLS-8-6	1/2	3/8	22	1.34	1.30
169PLS-8-8	1/2	1/2	22	1.34	1.30

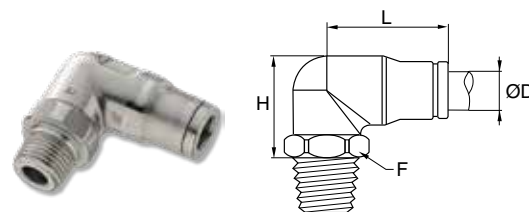

169PLS Male Elbow - Metric Tube to BSPT

PART NO.	TUBE SIZE MM	BSPT	F MM	H MM	L MM
169PLS-4M-2R	4	1/8	13	18.00	19.00
169PLS-4M-4R	4	1/4	14	18.00	19.00
169PLS-6M-2R	6	1/8	13	20.00	24.00
169PLS-6M-4R	6	1/4	14	20.00	23.00
169PLS-8M-2R	8	1/8	13	24.50	32.00
169PLS-8M-4R	8	1/4	14	23.50	24.00
169PLS-8M-6R	8	3/8	19	23.00	25.00
169PLS-10M-4R	10	1/4	17	27.00	31.00
169PLS-10M-6R	10	3/8	19	26.00	31.00
169PLS-12M-4R	12	1/4	22	31.50	33.00
169PLS-12M-6R	12	3/8	22	32.50	33.00
169PLS-12M-8R	12	1/2	22	27.50	33.00

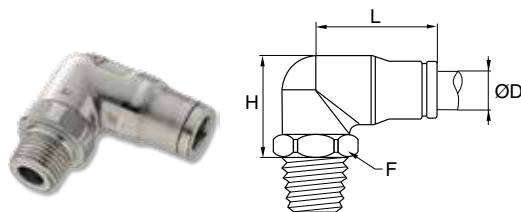

169PLS Male Elbow - Metric Tube to NPT

PART NO.	TUBE SIZE MM	NPT	F MM	H MM	L MM
169PLS-4M-2 (5/32 - 2)	4	1/8	13	17.50	19.00
169PLS-6M-2	6	1/8	13	20.00	22.50
169PLS-6M-4	6	1/4	14	20.00	22.50
169PLS-8M-2 (5/16 - 2)	8	1/8	13	25.00	24.00
169PLS-8M-4 (5/16 - 4)	8	1/4	14	24.00	24.00
169PLS-10M-4	10	1/4	17	27.50	27.50
169PLS-10M-6	10	3/8	19	28.50	26.50
169PLS-12M-4	12	1/4	22	31.50	32.50
169PLS-12M-6	12	3/8	22	32.50	32.50
169PLS-12M-8	12	1/2	22	27.50	32.50

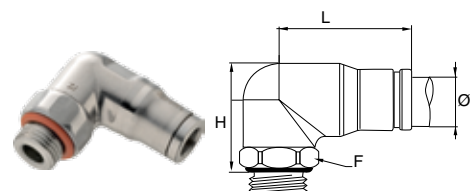

169PLS Male Elbow - Metric Tube to BSPP

PART NO.	TUBE SIZE MM	BSPP	F MM	H MM	L MM
169PLS-4M-2G	4	1/8	10	22	19
169PLS-4M-4G	4	1/4	17	20	19
169PLS-6M-2G	6	1/8	13	24	24
169PLS-6M-4G	6	1/4	17	22	24
169PLS-8M-2G	8	1/8	13	25	25
169PLS-8M-4G	8	1/4	17	25	25
169PLS-8M-6G	8	3/8	21	23	25
169PLS-10M-4G	10	1/4	18	43	31
169PLS-10M-6G	10	3/8	21	40	31
169PLS-12M-4G	12	1/4	17	33	33
169PLS-12M-6G	12	3/8	21	33	33
169PLS-12M-8G	12	1/2	24	30	33

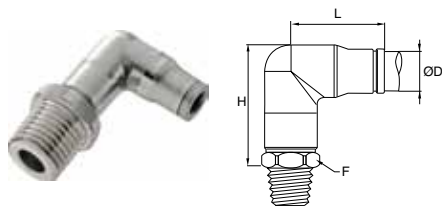

169PLSX Extended Male Elbow - Metric Tube to NPT

PART NO.	TUBE SIZE MM	NPT	F MM	H MM	L MM
169PLSX-4M-2	4	1/8	11	25.5	18.5
169PLSX-6M-2	6	1/8	13	29	22.5
169PLSX-6M-4	6	1/4	14	29	22.5
169PLSX-8M-2	8	1/8	14	34	24
169PLSX-8M-4	8	1/4	14	34	24
169PLSX-10M-4	10	1/4	19	39.5	30
169PLSX-10M-6	10	3/8	19	39.5	30

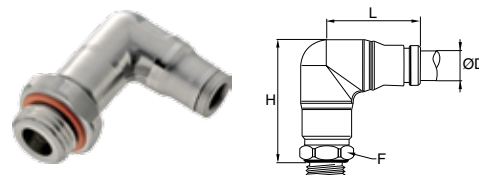

169PLSX Extended Male Elbow - Metric Tube to BSPP, M5

PART NO.	TUBE SIZE MM	BSPP / M5	F MM	H MM	L MM
169PLSX-4M-M5	4	M5X0.8	10	27.00	19
169PLSX-4M-2G	4	1/8	13	27.00	19
169PLSX-4M-4G	4	1/4	17	27.00	19
169PLSX-6M-M5	6	M5X0.8	13	33.00	24
169PLSX-6M-2G	6	1/8	13	33.00	24
169PLSX-6M-4G	6	1/4	17	32.00	24
169PLSX-8M-2G	8	1/8	14	35.00	25
169PLSX-8M-4G	8	1/4	17	35.00	25
169PLSX-8M-6G	8	3/8	21	34.50	25
169PLSX-10M-4G	10	1/4	18	43.00	31
169PLSX-10M-6G	10	3/8	21	42.00	31

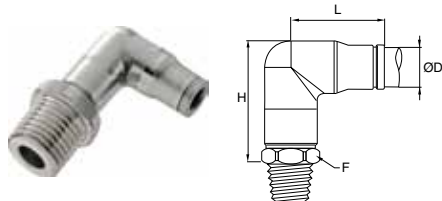

169PLSX Extended Male Elbow - Metric Tube to BSPT

PART NO.	TUBE SIZE MM	BSPT	F MM	H MM	L MM
169PLSX-4M-2R	4	1/8	10	25	19.00
169PLSX-4M-4R	4	1/4	14	26	19.00
169PLSX-6M-2R	6	1/8	13	30	24.00
169PLSX-6M-4R	6	1/4	14	30	24.00
169PLSX-8M-2R	8	1/8	14	34	24.90
169PLSX-8M-4R	8	1/4	14	34	24.90
169PLSX-10M-4R	10	1/4	19	39	31.00
169PLSX-10M-6R	10	3/8	19	39	31.00

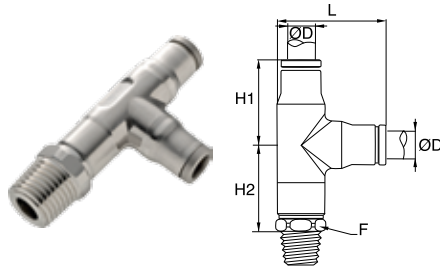

171PLS Male Run Tee - Metric Tube to NPT

PART NO.	TUBE SIZE MM	NPT	F MM	H1 MM	H2 MM	L MM
171PLS-4M-2 (5/32-2)	4	1/8	11	19.00	21.00	25.00
171PLS-6M-2	6	1/8	13	21.00	24.00	27.00
171PLS-6M-4	6	1/4	14	21.00	24.00	27.50
171PLS-8M-2 (5/16 - 2)	8	1/8	14	24.00	26.50	30.50
171PLS-8M-4 (5/16 - 4)	8	1/4	14	24.00	26.50	30.50
171PLS-10M-4	10	1/4	19	29.50	31.00	37.50
171PLS-10M-6	10	3/8	19	29.50	31.00	37.50

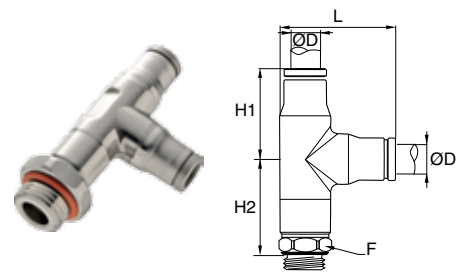

171PLS Male Run Tee - Metric Tube to BSPP, M5

PART NO.	TUBE SIZE MM	BSPP / M5	F MM	H1 MM	H2 MM	L MM
171PLS-4M-M5	4	M5X0.8	10	19.00	21.50	24.50
171PLS-4M-2G	4	1/8	13	19.00	21.50	25.50
171PLS-4M-4G	4	1/4	17	19.00	21.50	28.30
171PLS-6M-2G	6	1/8	13	24.00	26.50	30.00
171PLS-6M-4G	6	1/4	17	24.00	25.90	32.00
171PLS-8M-2G	8	1/8	14	25.00	27.50	32.00
171PLS-8M-4G	8	1/4	17	25.00	28.20	33.50
171PLS-8M-6G	8	3/8	21	25.00	27.30	35.50
171PLS-10M-4G	10	1/4	18	31.00	35.60	39.60
171PLS-10M-6G	10	3/8	21	31.00	33.60	41.00

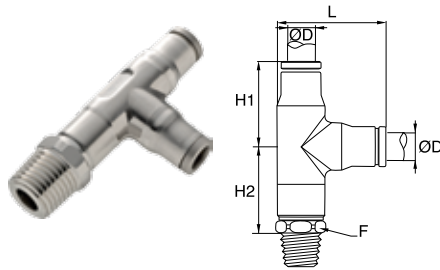

171PLS Male Run Tee - Metric Tube to BSPT

PART NO.	TUBE SIZE MM	BSPT	F MM	H1 MM	H2 MM	L MM
171PLS-4M-2R	4	1/8	10	19.00	20.00	24.50
171PLS-4M-4R	4	1/4	14	19.00	20.00	26.50
171PLS-6M-2R	6	1/8	13	24.00	24.00	30.00
171PLS-6M-4R	6	1/4	14	24.00	24.00	30.00
171PLS-8M-2R	8	1/8	14	25.00	27.00	32.00
171PLS-8M-4R	8	1/4	14	25.00	27.00	32.00
171PLS-8M-6R	8	3/8	19	25.00	26.00	34.50
171PLS-10M-4R	10	1/4	19	31.00	31.00	39.00
171PLS-10M-6R	10	3/8	19	31.00	31.00	39.00

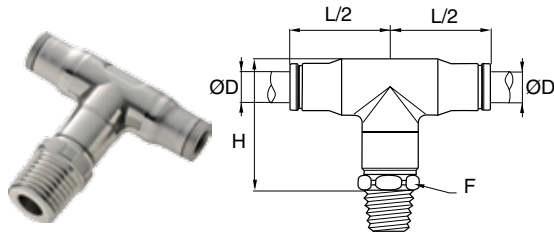

172PLS Male Branch Tee - Metric Tube to NPT

PART NO.	TUBE SIZE MM	NPT	F MM	H MM	L/2 MM
172PLS-4M-2 (5/32 - 2)	4	1/8	11	22.00	19.50
172PLS-6M-2	6	1/8	13	30.00	22.50
172PLS-6M-4	6	1/4	14	30.00	22.50
172PLS-8M-2 (5/16 - 2)	8	1/8	14	34.00	24.00
172PLS-8M-4 (5/16 - 4)	8	1/4	14	34.00	24.00
172PLS-10M-4	10	1/4	19	40.00	29.50
172PLS-10M-6	10	3/8	19	40.00	29.50

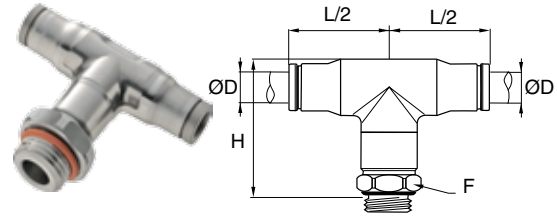

172PLS Male Branch Tee - Metric Tube to BSPP, M5

PART NO.	TUBE SIZE MM	BSPP / M5	F MM	H MM	L/2 MM
172PLS-4M-M5	4	M5X0.8	10	26.80	19
172PLS-4M-2G	4	1/8	13	27.30	19
172PLS-4M-4G	4	1/4	17	27.30	19
172PLS-6M-M5	6	M5X0.8	13	33.50	24
172PLS-6M-2G	6	1/8	13	32.70	24
172PLS-6M-4G	6	1/4	17	32.00	24
172PLS-8M-2G	8	1/8	14	34.80	25
172PLS-8M-4G	8	1/4	17	35.00	25
172PLS-8M-6G	8	3/8	21	34.50	25
172PLS-10M-4G	10	1/4	18	43.20	31
172PLS-10M-6G	10	3/8	21	41.20	31

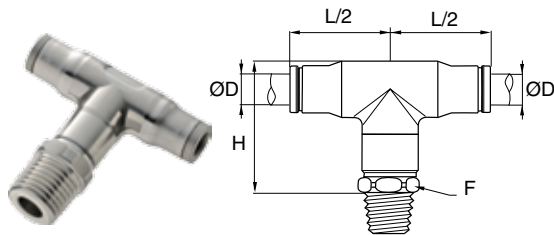

172PLS Male Branch Tee - Metric Tube to BSPT

PART NO.	TUBE SIZE MM	BSPT	F MM	H MM	L/2 MM
172PLS-4M-2R	4	1/8	11	25.00	19.00
172PLS-4M-4R	4	1/4	14	26.00	19.00
172PLS-6M-2R	6	1/8	13	30.00	24.00
172PLS-6M-4R	6	1/4	14	30.00	24.00
172PLS-8M-2R	8	1/8	14	34.00	25.00
172PLS-8M-4R	8	1/4	14	34.00	25.00
172PLS-8M-6R	8	3/8	19	33.00	25.00
172PLS-10M-4R	10	1/4	19	39.00	31.00
172PLS-10M-6R	10	3/8	19	39.00	31.00

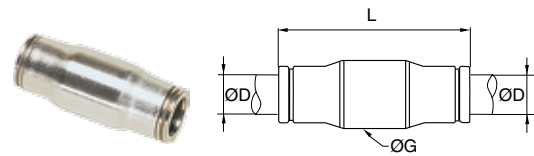

62PLS Union - Inch Tube

PART NO.	TUBE SIZE IN	G IN	H IN
62PLS-3	3/16	.39	1.18
62PLS-4	1/4	.47	1.38
62PLS-6	3/8	.69	1.81
62PLS-8	1/2	.79	1.89

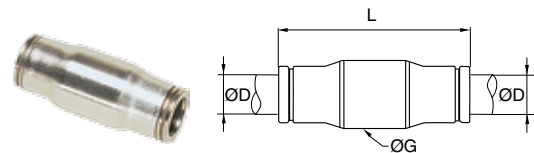

62PLS Union - Metric Tube

PART NO.	TUBE SIZE MM	G MM	H MM
62PLS-4M (5/32)	4	10.00	30.00
62PLS-6M	6	12.00	37.00
62PLS-8M (5/16)	8	15.00	38.00
62PLS-10M	10	17.00	49.00
62PLS-12M	12	19.50	49.50

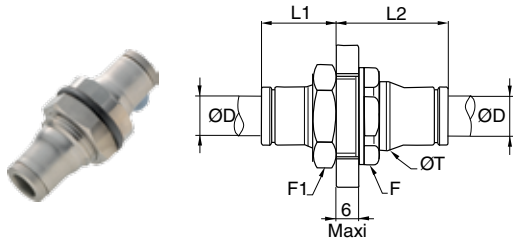

62PLSBH Bulkhead Union - Inch Tube

PART NO.	TUBE SIZE IN	F MM	F1 MM	L1 IN	L2 IN	T IN
62PLSBH-3	3/16	17	13	.59	.83	.49
62PLSBH-4	1/4	19	17	.67	.89	.57
62PLSBH-6	3/8	27	22	.87	1.08	.81
62PLSBH-8	1/2	27	27	.94	1.14	.79

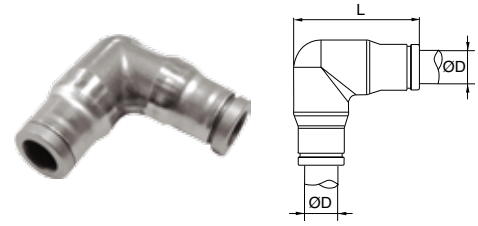

165PLS Union Elbow - Metric Tube

PART NO.	TUBE SIZE MM	L MM
165PLS-4M (5/32)	4	24.00
165PLS-6M	6	30.00
165PLS-8M (5/16)	8	32.20
165PLS-10M	10	39.00
165PLS-12M	12	43.00

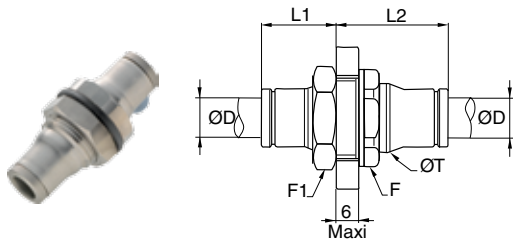

62PLSBH Bulkhead Union - Metric Tube

PART NO.	TUBE SIZE MM	F MM	F1 MM	L1 MM	L2 MM	T MM
62PLSBH-4M (5/32)	4	14	13	15	18	13
62PLSBH-6M	6	17	17	19	21	15
62PLSBH-8M (5/16)	8	19	19	20	22	17
62PLSBH-10M	10	22	22	24	26	21
62PLSBH-12M	12	24	24	25	26	23

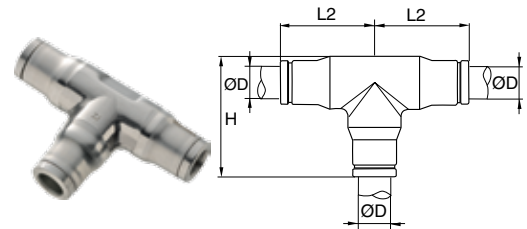

164PLS Union Tee - Inch Tube

PART NO.	TUBE SIZE IN	H IN	L2 IN
164PLS-3	3/16	.89	.69
164PLS-4	1/4	1.06	.83
164PLS-6	3/8	1.48	1.12
164PLS-8	1/2	1.61	1.22

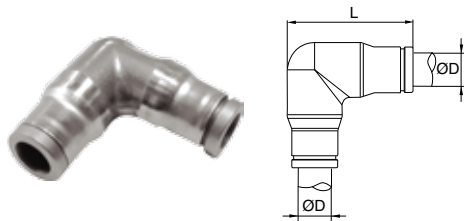

165PLS Union Elbow - Inch Tube

PART NO.	TUBE SIZE IN	L IN
165PLS-3	3/16	.96
165PLS-4	1/4	1.14
165PLS-6	3/8	1.56
165PLS-8	1/2	1.61

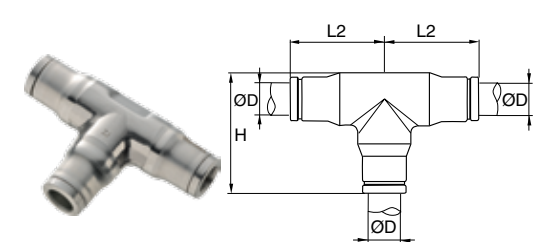

164PLS Union Tee - Metric Tube

PART NO.	TUBE SIZE MM	H MM	L2 MM
164PLS-4M (5/32)	4	24	19
164PLS-6M	6	30	24
164PLS-8M (5/16)	8	32	25
164PLS-10M	10	39	31
164PLS-12M	12	43	33

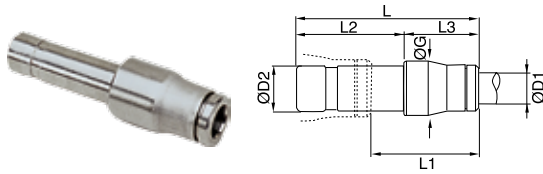

67PLS Tube Reducer - Metric

PART NO.	TUBE 1 SIZE MM	TUBE 2 SIZE MM	G MM	L MM	L1 MM	L2 MM	L3 MM
67PLS-4M-6M	4	6	10	35	19.0	19	16
67PLS-4M-8M	4	8	10	34	17.0	20	14
67PLS-6M-8M	6	8	12	42	24.0	23	19
67PLS-6M-10M	6	10	12	42	19.0	25	17
67PLS-8M-10M	8	10	15	45	22.5	25	19
67PLS-8M-12M	8	12	15	43	20.0	26	17
67PLS-10M-12M	10	12	17	51	23.0	26	25

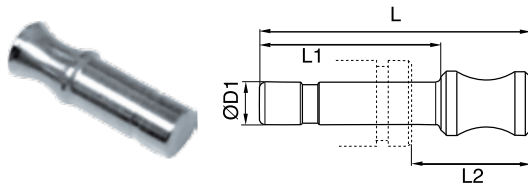

639PLS Plug - Metric

PART NO.	TUBE 1 SIZE MM	L MM	L1 MM	L2 MM
639PLS-4M	4	25.40	17.00	11.10
639PLS-6M	6	30.40	19.50	13.50
639PLS-8M	8	33.00	20.00	14.40
639PLS-10M	10	40.00	25.00	17.00
639PLS-12M	12	43.00	26.00	18.70

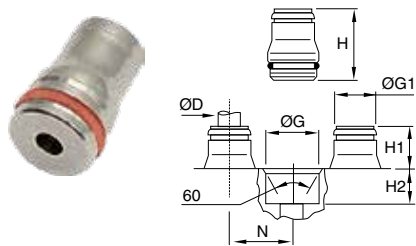

PLSC Cartridge - Metric

PART NO.	TUBE SIZE MM	G +.1 - 0 MM	G1 MM	H MM	H1 MM	H2 MM	N MM
PLSC-4M	4	9.80	8	18.00	9.50	8.50	11.00
PLSC-6M	6	12.10	10	20.00	11.50	8.50	13.50
PLSC-8M	8	14.80	13	22.00	13.50	8.50	16.00
PLSC-10M	10	17.50	15	25.50	15.00	10.50	20.00
PLSC-12M	12	20.00	17	26.00	15.50	10.50	22.50



Oscillating Elbows

Parker's oscillating fittings are designed to satisfy the requirements of industrial automation and robotics. The oscillating fitting features low-friction washers enabling the fitting to rotate in conjunction with the stroke of the cylinder piston.

Product Features:

- Glass reinforced nylon 6.6 body
- Nylon collar
- Stainless Steel gripping ring
- Nitrile D seal
- Nitrile o-ring
- Nickel-plated brass threads

Markets:

- Robotics
- Pneumatics
- Textile
- Packaging
- Semi-conductors

Applications:

- Air
- Cutting Fluids
- Inert Gases

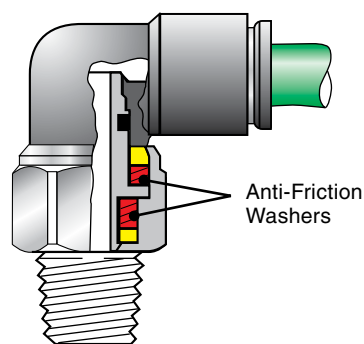

Specifications:

Pressure Range Up to 290 psi depending on tubing

Temperature Range -4° to +175°F

Compatible Tubing:

- Semi-rigid nylon
- Polyurethane 95 Durometer Shore A
- Nylon
- Fluoropolymer

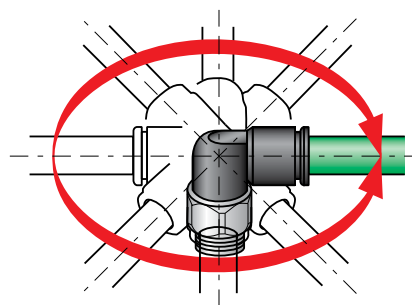

O.D. TUBE INCH & MM	5/32 & 4	1/4 & 6	8	10	12
"MAXIMUM ROTATION SPEED IN RADIAN/SECOND"	190	160	120	90	80

<p>Tube to Male NPT</p>	<p>W369PLPO Male Elbow</p>  <p>p. A58</p>	<p>Metric Tube to Male BSPT</p>	<p>W369PLPO Male Elbow</p>  <p>p. A58</p>	<p>Metric Tube to Male BSPP</p>	<p>369PLPO Male Elbow</p>  <p>p. A58</p>
-----------------------------	---	-------------------------------------	---	-------------------------------------	--

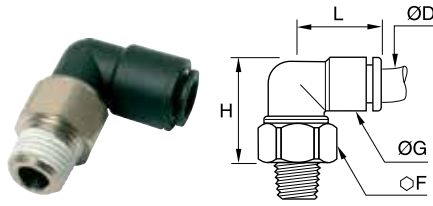

W369PLPO Oscillating Compact Elbow - NPT

PART NO.	TUBE SIZE (IN)	NPT	F	G	H	L
W369PLPO-4M-2	5/32 (4M)	1/8	12	.43	.85	.69
W369PLPO-4-2	1/4	1/8	14	.55	1.04	.81
W369PLPO-4-4	1/4	1/4	14	.55	1.04	.81

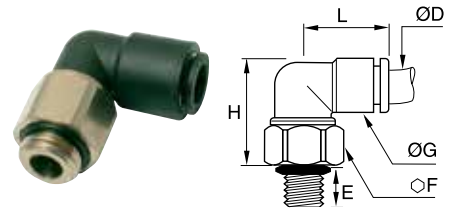

369PLPO Oscillating Compact Elbow - BSPP, M5

PART NO.	TUBE SIZE (MM)	M5/ BSPP	E	F	G	H	L
369PLPO-4M-M5	4	M5X0.8	3.0	12	11.0	24.5	17.5
369PLPO-4M-2G	4	1/8	5.0	13	11.0	23.0	17.5
369PLPO-6M-M5	6	M5X0.8	3.0	12	14.0	27.5	20.5
369PLPO-6M-2G	6	1/8	5.0	14	14.0	27.0	20.5
369PLPO-6M-4G	6	1/4	5.5	16	14.0	25.5	20.5
369PLPO-8M-2G	8	1/8	5.0	17	16.0	33.5	23.5
369PLPO-8M-4G	8	1/4	5.5	17	16.0	31.0	23.5
369PLPO-8M-6G	8	3/8	5.5	20	16.0	29.5	23.5
369PLPO-10M-4G	10	1/4	5.5	19	19.5	50.0	29.0
369PLPO-10M-6G	10	3/8	5.5	20	19.5	37.0	29.0
369PLPO-12M-4G	12	1/4	5.5	21	22.0	46.5	33.5
369PLPO-12M-6G	12	3/8	5.5	21	22.0	45.5	33.5

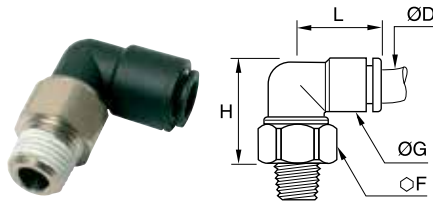

W369PLPO Oscillating Compact Elbow - BSPT

PART NO.	TUBE SIZE (MM)	BSPT	F	G	H	L
W369PLPO-4M-2R	4	1/8	12	11.0	22.0	17.5
W369PLPO-6M-2R	6	1/8	14	14.0	26.5	20.5
W369PLPO-6M-4R	6	1/4	14	14.0	23.5	20.5
W369PLPO-8M-2R	8	1/8	17	16.0	32.0	23.5
W369PLPO-8M-4R	8	1/4	17	16.0	29.0	23.5
W369PLPO-8M-6R	8	3/8	17	16.0	25.0	23.5
W369PLPO-10M-4R	10	1/4	19	19.5	37.5	29.0
W369PLPO-10M-6R	10	3/8	19	19.5	33.5	29.0
W369PLPO-12M-4R	12	1/4	21	22.0	44.5	33.5
W369PLPO-12M-6R	12	3/8	21	22.0	41.0	33.5